

weldtech

MST 140i

**Gas/Gasless Multi-Process
Welder**

WORKSHOP SERIES



OPERATING INSTRUCTIONS

www.weldtech.net.nz



We Appreciate Your Business!

Congratulations on your new Weldtech product!

The Weldtech range from Euroquip uses latest technology design and engineering to produce welding products that combine market leading value and features with durability. Designed for discerning operators who seek professional results and product quality without the price tag of a full professional setup. Design emphasis is placed on simple, functional design and operation. Weldtech product is subject to stringent quality control and designed and manufactured to NZ & Australian standards.

Common use of Weldtech products include:

- Light Engineering
- Automotive
- Home/Hobby Engineering
- Farming
- Maintenance & Repairs

For industrial welding solutions, check out the Strata range from Euroquip:

www.strata.co.nz

Euroquip is a market leading provider of innovative power equipment solutions to a wide range of industries across New Zealand and Australia. Key product categories are; welding equipment, air compressors, power generators and cleaning equipment.

Euroquip's slogan is 'empowering industries', find out more about the advantage Euroquip brings at **www.euroquip.co.nz**.

Providing exceptional product support is a key component of Euroquip's market leading customer advantage focus. As part of this program, it is required for all products to be registered with Euroquip to qualify for product support. Products not registered with Euroquip are supported by a base 12 month warranty only. Spare parts and technical support will not be available for an unregistered product outside of this base warranty period. If a Euroquip dealer has not already registered your product, please register it online at www.euroquip.co.nz. To request a physical registration form, please contact Euroquip customer service on 0800 387 678.

Contents

1	CONTENTS.....	3
2	BASIC SPECIFICATIONS	6
3	KNOW YOUR MACHINE.....	7
3.1	Front	7
3.2	Side / Wire Feeder Compartment	7
3.3	Rear	7
4	CONTROLS EXPLAINED	8
4.1	Control Panel.....	8
5	POWER SUPPLY	9
5.1	Electrical Connection.....	9
5.2	Extension Leads.....	9
5.3	Generator Use	9
6	OPERATING ENVIRONMENT.....	9
6.1	Location	9
6.2	Ventilation	9
7	BASIC OPERATION	10
7.1	MIG Welding.....	10
7.1.1	Fitting Wire Spool & Loading Wire Feeder.....	10
7.1.2	Gasless Welding Setup	11
7.1.3	Gas MIG Welding Setup	11
7.2	Stick (MMA) Welding Operation	12
7.3	TIG Operation.....	12
8	ACCESSORIES & SPARE PARTS	13
8.1	Spares & Accessories:.....	13
8.2	Primary Schematic Circuit Diagram.....	13
9	CARE & MAINTENANCE.....	14
9.1	Keep your Welding Machine in Top Condition	14
9.2	Storing the Welder	14
10	GENERAL GUIDE TO WELDING	15
10.1	Duty Cycle Rating	15
10.2	Choosing a Welding Process – MIG, Stick or TIG?	15
10.2.1	The Stick (MMA) Process	15
10.2.2	The TIG Process.....	16
10.2.3	The MIG Process	16
10.3	Joint Preparations	17
11	MIG BASIC WELDING GUIDE.....	19

11.1	MIG Basic Welding Techniques	19
11.2	Gas Metal Arc Welding (GMAW)	19
11.3	Flux Cored Arc Welding (FCAW)	19
11.4	Position of MIG Torch	20
11.5	Distance from the MIG Torch Nozzle to the Work Piece	20
11.6	Travel Speed	20
11.7	MIG Welding (GMAW) Variables	21
11.7.1	Preselected Variables	21
11.7.2	Primary Adjustable Variables	21
11.7.3	Secondary Adjustable Variables	21
11.8	Establishing the Arc and Making Weld Beads	23
11.9	MIG Voltage & Wire Speed Settings	23
11.9.1	Setting Wire Speed/Amperage	23
11.9.2	Setting Voltage	23
11.9.3	Changing to a different welding wire	23
11.9.4	How to determine correct Wire Speed/Voltage Setting	24
11.10	Suggested Settings for Typical MIG Applications	24
11.11	Welding wire Size Selection	24
11.12	MIG Welding Troubleshooting	25
11.12.1	Porosity Problems	25
11.12.2	Wire Feed Problems	26
11.12.3	Weld Quality Problems	27
12	STICK (MMA) BASIC WELDING GUIDE	28
12.1	Size of Electrodes	28
12.2	Storage of Electrodes	28
12.3	Electrode Polarity	28
12.4	Effects of Stick (MMA) Welding on Various Materials.....	28
12.4.1	High Tensile and Alloy Steels.....	28
12.4.2	Manganese Steels	29
12.4.3	Cast Iron	29
12.5	Types of Electrodes	29
12.5.1	MILD STEEL:	29
12.5.2	CAST IRON:.....	29
12.5.3	STAINLESS STEEL:	29
12.6	Suggested Settings for Typical Stick (MMA) Applications	29
12.7	MMA Welding Techniques	30
12.7.1	A Word for Beginners.....	30
12.7.2	The Welder.....	30
12.7.3	Striking the Arc.....	30

12.7.4	Arc Length	31
12.7.5	Rate of Travel	31
12.8	Making Welded Joints	31
12.8.1	Butt Welds.....	31
12.8.2	Fillet Welds.....	32
12.8.3	Vertical Welds	33
12.8.4	Overhead Welds.....	34
12.9	MMA (Stick) Troubleshooting	34
13	TIG BASIC WELDING GUIDE	36
13.1	TIG Electrode Selection and Preparation	36
13.1.1	Electrode Polarity.....	36
13.1.2	Preparing Tungsten for DC Electrode Negative (DCEN) Welding	37
13.1.3	Shielding Gas for TIG Welding.....	38
13.1.4	Typical TIG Welding Settings	38
13.2	TIG Welding Troubleshooting.....	39
14	SAFETY	40
14.1	Store and Retain this Manual.....	40
14.2	Important Safety Information	40
14.3	Welding Operation	40
14.4	Welding Safety Instructions & Warnings.....	42
14.4.1	Personal Safety.....	43
14.4.2	Arc Rays can Burn Eyes and Skin	43
14.4.3	Noise Can Damage Hearing	43
14.4.4	Work Environment Safety	44
14.4.5	Electricity Can Kill.....	44
14.4.6	Fumes And Gases.....	45
14.4.7	Fire & Explosive Risks.....	46
14.4.8	Sparks & Hot Metal.....	46
14.4.9	Gas Cylinders.....	47
15	WARRANTY	48

2 BASIC SPECIFICATIONS

Model	MST140i
Standard	AS 60974.1
Power Supply	~230V +/- 10% 50hz Single Phase
Factory Fitted Supply Plug Rating	10A
Effective Input Current ($I_{1\text{eff}}$)	8.95A
Maximum Input Current ($I_{1\text{max}}$)	16.3A
Nominal Open Circuit Voltage	60V
Output Terminals	Dinse style 10-25
Protection Class	IP21S
Weight	6.5kg
Dimensions	L350 x W10 x H290mm
MIG Welding	
Welding Output	50A/16.5V - 140A/20V
Duty Cycle	130A / 20V @ 26% 86A / 18.1V @ 60% 66A / 17.2V @ 100%
Spool Size	100mm (1kg)
MIG Wire Sizes	0.6, 0.8, 0.9mm
MIG Wire Types	Gasless, Solid Steel, Solid Stainless-Steel
Stick (MMA) Welding	
Welding Output	20/20.4V – 120A/24.8V
Duty Cycle	120A / 24.8V @ 30% 86A / 23.4V @ 60% 66A / 22.6V @ 100%
MMA Electrode Size	1.6 – 3.2mm
TIG Welding	
Welding Output	20/20.4V – 120A/24.8V
Duty Cycle	120A / 14.8V @ 30% 86A / 13.4V @ 60% 66A / 12.6V @ 100%
TIG Tungsten Size	1.6 – 2.4mm

Table 1

3 KNOW YOUR MACHINE

3.1 Front

1. Control panel
2. Negative (-) Cable Connection Socket
3. Positive (+) Cable Connection Socket
4. Polarity Cable for MIG Torch
5. MIG Torch



Figure 1

3.2 Side / Wire Feeder Compartment

1. Spool Post
2. Spool Twist-Lock Retainer
3. Wire Inlet Guide
4. Wire Feed Tension Adjustment Lever
5. Wire Feed Tension Arm/Top Roller
6. Drive Roller (Partially visible)
7. Drive Roller Retainer
8. Torch Cable Connection/Housing

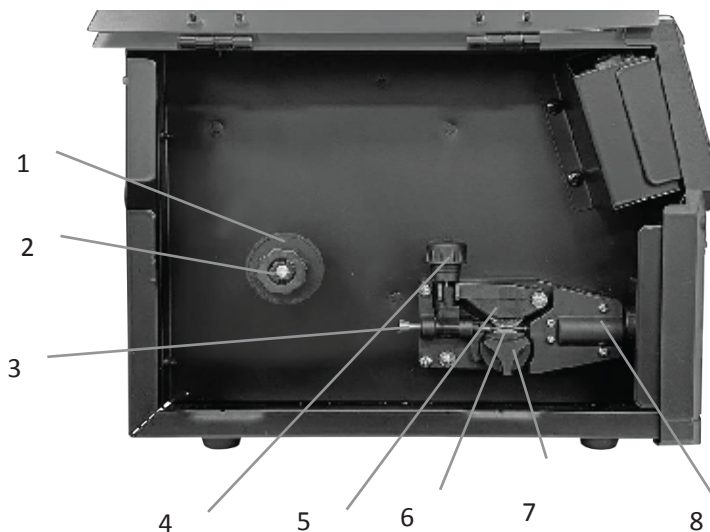

3.3 Rear

1. Mains Power Switch
2. 230V Mains Power Input Lead
3. MIG Gas Inlet Connection



4 CONTROLS EXPLAINED

4.1 Control Panel

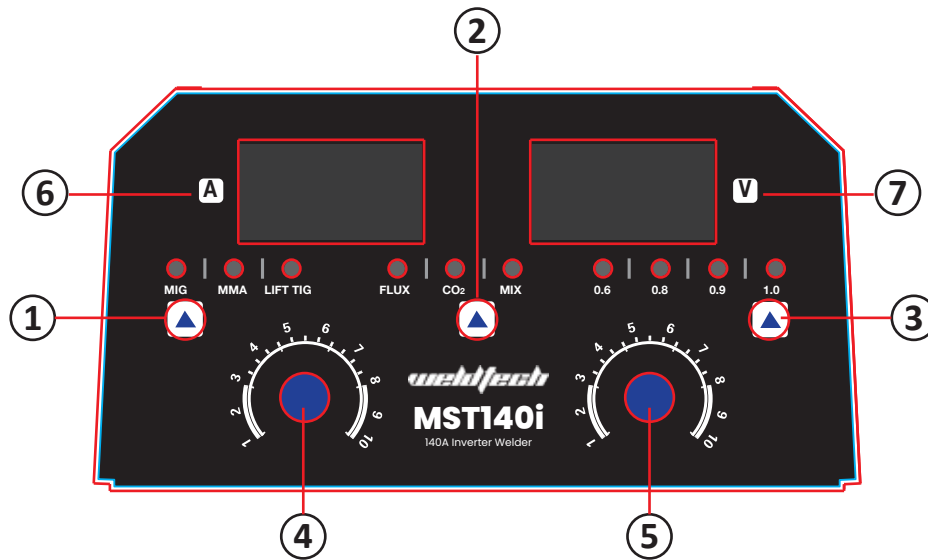

Figure 2

1. Process Mode Selection

Select MIG, TIG, or Stick Mode

Note that different modes require different each/torch polarity. Refer to chart inside wire feeder door, and/or further information throughout this manual for correct polarity settings.

2. MIG Gas Selection

Gasless = Select when using gasless flux-cored wire

CO₂ = Select when using 100% CO₂ gas

Ar/MIX = Select when using Argon or Argon+CO₂ mixed gas

3. MIG Wire Size Selection

Select the wire size in use

4. Primary Output Control

MIG: Adjusts heat (volts) and wire speed (amps) simultaneously. Use the material thickness dial markings as a guide.

Stick: Adjusts main current (amps)

TIG: Adjusts main current (amps)

5. Secondary Control

MIG: Tim / fine output adjustment -5 to +5, use to 'fine tune' the arc & minimise spatter.

Stick: Arc Force adjustment 0-50%, delivers a short peak of current if machine sense the arc is faltering or electrode is sticking. Eg: If output is set at 50A and Arc Force at 20%, current peak will be 120A. The max current peak is limited by the max output of the machine (120A in stick mode).

TIG: Slope-Up Time 0-3 sec, output will gradually ramp up after starting the arc. This assists with easier arc ignition, reduced tungsten sticking, and better weld appearance.

6. Amps LED Display

Displays Amps output in all modes.

In MIG mode, amps are impacted by / related to wire speed.

7. Volts LED Display

MIG: Displays volts output.

Stick: Displays Arc Force 0-50%.

TIG: Displays Slope-Up Time 0-3 sec.

8. Thermal Overload: If LED displays "HOT", this indicates that max duty-cycle has been reached. Welding output will be disabled and "HOT" will remain displayed until machine cools.

5 POWER SUPPLY

5.1 Electrical Connection

This machine is designed to operate on a 10A ~230V AC power supply.

5.2 Extension Leads

If an extension cord must be used, it should be minimum cable core size 2.0mm² for length of up to 10m, or minimum 2.5mm² for lengths over 10m. Using extension leads of over 20m is not recommended.

5.3 Generator Use

This machine can be used with a suitable generator. Generator size should be not less than 7kva. Avoid using poor, low-quality generators as these have the greatest risk of power spikes etc. A suitable quality generator should have a THD (total harmonic distortion) rating of NOT more than 6%. Most reputable generator suppliers will be able to specify the THD ratings on their product.

Any damage caused by poor quality generator power supply or incorrect use is not covered under warranty.

IMPORTANT 'GOLDEN RULES' FOR GENERATOR USE:

Following these rules will significantly reduce the risk of any damage resulting from generator power supply.

1. Do NOT plug welder into generator until AFTER generator has started and is running smoothly.
2. UNPLUG welder from generator BEFORE shutting generator down/turning generator off.
3. NEVER let your generator run out of fuel whilst the welder is plugged in.

Following these Golden Rules will significantly reduce the risk of any damage resulting from generator power supply.

6 OPERATING ENVIRONMENT

6.1 Location

The machine has electrical components and control circuit boards which may be damaged by excessive moisture, dust and dirt, so a clean and dry operating environment is essential for reliable product life.

6.2 Ventilation

Adequate ventilation is required to provide proper cooling for the machine. Ensure that the machine is placed on a stable level surface where clean cool air can easily flow through the unit.

7 BASIC OPERATION

7.1 MIG Welding

WARNING! Before changing the feed roller or wire spool, ensure that the mains power is switched off.

7.1.1 Fitting Wire Spool & Loading Wire Feeder

1. Open the wire feeder compartment door.
2. Remove the Spool Twist-Lock Retainer 'Nut' (3.2.2) & spring
3. Fit the wire spool to the Spool Post, ensuring that the wire exits the spool from bottom of the spool.
4. Replace the Spool Twist-Lock Retainer 'Nut' (3.2.2) & spring
5. Feed the wire from the spool through the Wire Inlet Guide (3.2.3) into the wire feeder.
6. Release the Wire Feed Tension Arm (3.2.5) by pivoting the Wire Feed Tension Adjustment Lever (3.2.4) towards you from the vertical 'locked' position.
7. Check the wire Drive Roller (3.2.6) groove matches the selected MIG wire type and size. The drive roller will have two different sized grooves; the size of the groove in use is stamped on the side of the drive roller. For gasless flux-cored wire the drive roller groove should have a serrated / knurled groove. For solid steel or stainless MIG wire, the drive roller groove should have a 'V' shaped profile. If necessary, remove and change the drive roller by removing the Drive Roller Retainer (3.2.7). Once the correct drive roller is selected and fitted and the Drive Roller Retainer is secured in place, manually feed the wire through the Wire Inlet Guide (3.2.3), through the drive roller groove and into the outlet wire tube/liner inside the torch housing (3.2.8) & MIG torch cable.
8. Ensuring that the wire is correctly seated in the centre of the drive roller groove, replace the Wire Feed Tension Arm (3.2.5) and lock it into place by pivoting the Wire Feed Tension Adjustment Lever (3.2.4) back to the vertical position.
9. Adjust wire feed tension by winding the knob on the Wire Feed Tension Adjustment Lever (3.2.4). Clockwise will increase tension, anticlockwise will decrease drive tension.

TIP! Ideal tension is as little as possible, while maintaining a consistent wire feed with no drive roller slippage.

Check all other causes of excess wire feeding friction causing slippage first, such as; incorrect/worn drive roller, worn/damaged torch consumables, blocked/damaged torch wire guide liner, before increasing wire feed tension. There is a number scale on the Wire Feed Tension Adjustment Lever (4) to indicate the adjustment position. The higher the number indicated, the higher the tension that is set.

WARNING! The use of excessive feed tension will cause rapid and premature wear of the drive roller, the support bearing and the drive motor/gearbox.

10. Double check that the correct matching MIG wire, drive roller (3.2.6) and MIG torch tip sizes are fitted.
11. Connect the machine to suitable mains power using the mains input power lead (3.3.2). Switch the mains power switch (3.3.1) ON to power up the machine.
12. Set welding process selector (4.1.1) to 'MIG'
13. Remove the contact tip from the torch and lay the torch cable out as straight as possible.
14. Pull the MIG torch trigger until the wire feeds out through the end of the MIG torch.
15. Replace the tip on the MIG torch and trim off any excess wire.

7.1.2 Gasless Welding Setup

1. Connect the earth cable to the Positive (+) output socket (3.1.3)
2. Connect the earth clamp to the work piece. Contact with the work piece must be firm contact with clean, bare metal, with no corrosion, paint, or scale at the contact point.
3. Connect the MIG Torch Polarity Cable (3.1.4) to the Negative (-) output socket (3.1.2). **Note:** if this connection is not made, there will be no electrical connection to the welding torch!
4. Set process selector (4.1.1) to 'MIG'
5. Set gas selector (4.1.2) to 'GASLESS'
6. Set wire size selector (4.1.3) to match the wire size you are using
7. You're now ready to weld! Adjust main output (4.1.4) according to your material thickness, and refer to reference chart inside wire feeder door, and section 4.1 of this manual for further guidance.
8. **IMPORTANT:** With gasless welding, 'Drag' the torch so the wire is pointing back at the completed weld metal/joint, away from direction of travel. Remember "if there's slag, you drag"!

7.1.3 Gas MIG Welding Setup

NOTE: Gas MIG welding required optional Gas hose, Gas Regulator, Drive Roller for solid wire, and a Gas cylinder (Argon mix or CO₂).

1. Connect the earth cable quick connector to the Negative (-) output socket (3.1.2).
2. Connect the earth clamp to the work piece. Contact with the work piece must be firm contact with clean, bare metal, with no corrosion, paint, or scale at the contact point.
3. Connect the MIG Torch Polarity Cable (3.1.4) to the Positive (+) output socket (3.1.3).
Note: if this connection is not made, there will be no electrical connection to the welding torch!
4. Connect the gas regulator to a gas cylinder and connect the gas hose from the regulator to the gas inlet connection (3.3.3) on the rear of the machine. Ensure all hose connections are tight.
5. Open gas cylinder valve and adjust regulator. Flow should be between 10-25L/min depending on application.
6. Set process selector (4.1.1) to 'MIG'
7. Set gas selector (4.1.2) to either "CO₂" if using 100% CO₂ gas, or "Ar/MIX" if using an argon-mixed gas
8. Set wire size selector (4.1.3) to match the wire size you are using
9. You're now ready to weld! Adjust main output (4.1.4) according to your material thickness, and refer to reference chart inside wire feeder door, and section 4.1 of this manual for further guidance.
10. **IMPORTANT:** With gas MIG welding, 'Push' the torch so the wire is pointing away from the completed weld metal/joint and into the direction of travel.

7.2 Stick (MMA) Welding Operation

1. Connect the earth cable quick connector to the Negative (-) output socket (3.1.2).
2. Connect the earth clamp to the work piece. Contact with the work piece must be firm contact with clean, bare metal, with no corrosion, paint, or scale at the contact point.
3. Insert an electrode into the electrode holder and connect the electrode holder and work lead to the Positive (+) output socket (3.1.3).

NOTE: *This polarity connection configuration is valid for most GP (General Purpose) MMA electrodes. There are variances to this. If in doubt, check the electrode specifications or consult the electrode manufacturer.*

4. Connect the machine to suitable power. Switch the mains power switch (3.3.1) to 'on' to power up the machine.
5. Set process selector (4.1.1) to 'STICK'. You are now ready to weld!
6. Select the required output current using the left Primary Output Control (4.1.4). The Left LED display (4.1.6) will display the set amperage output.
7. Adjust Arc Force % setting via right Secondary Output Knob as/if required (4.1.5)
8. Refer to reference chart inside wire feeder door, and section 4.1 of this manual for further guidance.

7.3 TIG Operation

NOTE: TIG operation requires an optional TIG torch, Gas Regulator, and Gas Cylinder (Argon).

NOTE: This machine is a DC (Direct Current) output welder only, this means that it is unable to TIG weld 'reactive metals' such as Aluminium alloys and Brass (which require AC output). DC TIG output is suitable for steel, stainless-steel and copper.

1. Connect the earth cable to the Positive (+) output socket (3.1.3).
2. Connect the earth clamp to the work piece. Contact with the work piece must be firm contact with clean, bare metal, with no corrosion, paint or scale at the contact point.
3. Insert TIG torch power connection into the Negative (-) output socket (3.1.2).
4. Connect TIG torch gas line directly to the gas regulator, and ensure all connections are tight.
5. Open gas cylinder valve and adjust regulator. Flow should be between 5-25 l/min depending on application.
6. Connect the machine to suitable power. Switch the mains power switch (3.3.1) to 'I' to power up the machine.
7. Set process selector (4.1.1) to 'TIG'. You are now ready to weld!
8. Select the required output current using the left Primary Output Control (4.1.4). The Left LED display (4.1.6) will display the set amperage output.
9. Adjust Up-Slope setting via right Secondary Output Knob as/if required (4.1.5)
10. Refer to reference chart inside wire feeder door, and section 4.1 of this manual for further guidance.

8 ACCESSORIES & SPARE PARTS

8.1 Spares & Accessories:

Refer to following table for information on spares and accessories available for this machine:

Part / Accessory	Code / Details
MIG Torch Spares	BZL MB15 Series
TIG Torch	TWP17V-12-2D or Tig Kit WT-SSTIGKIT
Drive Rollers	DR2507 Series. TB17259 06-08V, TB17260 08-09K
Gas Regulator	GR102ARFL or GR105CO2
Gas Hose	31104
Trolley T100	WT115
Internal Parts / Components	

8.2 Primary Circuit Diagram

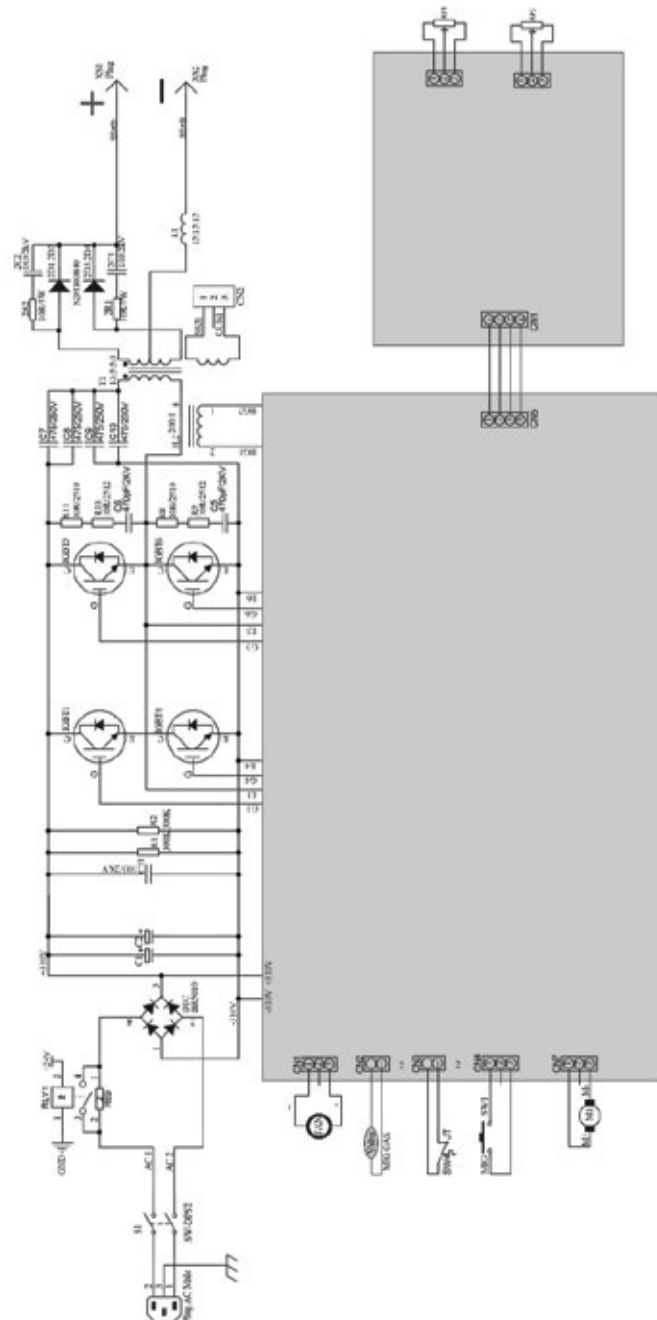

9 CARE & MAINTENANCE

9.1 Keep your Welding Machine in Top Condition

The user should take care of the machine as follows:

1. Regularly clean the ventilation slots
2. Keep the casing clean
3. Check all cables before use
4. Check electrode holders, work lead/clamps and welding torches before use
5. Replace worn electrode holders and earth clamps, which do not provide a good connection
6. Replace worn torch consumable parts in a timely manner
7. Replace worn wire drive components in a timely manner
8. Use a soft cloth or brush to clean electrical components. Do not use liquid cleaning products, water or especially solvents
9. Do not use compressed air to clean electrical components as this can force dirt and dust further into components, causing electrical short circuits
10. Check for damaged parts

WARNING! *Before performing cleaning/maintenance, replacing cables/connections, make sure the welding machine is switched off and disconnected from the power supply.*

If damaged, before further use, the welder must be carefully checked by a qualified person to determine that it will operate properly. Check for breakage of parts, mountings and other conditions that may affect its operation.

Have your welder repaired by an expert. An authorised service centre should properly repair a damaged part.

This appliance is manufactured in accordance with relevant safety standards. Only qualified persons should carry out repairing of electrical appliances, otherwise considerable danger for the user may result. Use only genuine replacement parts. Do not use modified or non-genuine parts.

9.2 Storing the Welder

When not in use the welder should be stored in the dry, dust-free and frost-free environment.

10 GENERAL GUIDE TO WELDING

10.1 Duty Cycle Rating

Weldclass welding machines are fitted with thermal overload protection which means the machine will cut out when it reaches a certain temperature, to prevent damage to components. The machine will then re-start when it returns to a safe temperature.

Duty cycle is a measure of the percentage of time a machine will operate within a certain time period at a given amperage. For example a duty cycle of 130A @ 26% means that a machine will operate at 130A for 2.6 minutes in a 10 minute time period. The machine will have to rest for the remaining 7.4 minutes to enable it to cool down.

The international standard for duty cycle rating is based on an ambient air temperature of 40°C with 50% humidity, over a 10 minute period. In an environment with temperatures exceeding 40°C, the duty cycle will be less than stated. In ambient temperature less than 40°C, duty cycle performance will be higher. There are numerous other factors that can influence actual duty cycle performance.

10.2 Choosing a Welding Process – MIG, Stick or TIG?

10.2.1 The Stick (MMA) Process

10.2.1.1 Description

The acronym MMA (or MMAW) stands for Manual Metal Arc Welding. ‘Manual’ refers to the fact that the MMA process requires the operator to apply filler metal (in contrast to MIG ‘semi-automatic’ welding where the machine feeds the filler metal into the weld). ‘Metal’ refers to the fact that the filler metal itself (the stick electrode) is used to conduct the welding current to the job. MMA welding is commonly known as ‘stick-electrode’ or ‘arc’ welding.

10.2.1.2 Process

The MMA process involves the electrode being touched on the job to ignite the arc. The electrode is held in the electrode holder and must be continually replaced as it is consumed. The electrode consists of a metal core, which is the filler metal, covered by a flux coating which shields the weld and prevents it from oxidising. During welding the flux forms into a slag covering the weld which is chipped off after the weld has formed.

10.2.1.3 Advantages

MMA welding offers several advantages over alternative welding processes. Primarily it has a greater capacity than MIG welding, or in other words it can weld heavier materials with the same amperage output. For this reason small, portable inverter welders like the WeldForce machines, have the capacity to weld with up to 3.2mm or 4mm electrodes making it suitable for a vast range of applications without the complication of shielding gas or wire feeding. Moreover, MMA welding is typically more ‘forgiving’ than MIG or TIG when welding rusty or dirty materials (which makes it ideal for maintenance applications).

10.2.1.4 Limitations

Traditionally, welding thin materials whilst avoiding “blow-through” can be tricky with the MMA process. This being said, however, welding thin materials with a WeldForce machine will be noticeably easier because the arc is so stable and the output can be very finely adjusted down to very low amps.

10.2.1.5 Materials

MMA welding can be used with a wide variety of electrodes including general purpose, low hydrogen, stainless steel, iron powder, hard facing & cast iron just to name a few.

10.2.2 The TIG Process

10.2.2.1 Description

The acronym TIG stands for Tungsten Inert Gas. Tungsten refers to the type of conductor (a tungsten electrode) that is used to transfer the welding current to the job and create the arc. Inert Gas refers to the fact that the process relies on an inert gas to prevent weld oxidation.

Also referred to as Gas Tungsten Arc Welding (GTAW).

10.2.2.2 Process

In simple terms, TIG welding is probably most similar to oxy flame welding. However, instead of a flame it uses an electrical arc to melt the job and filler metal, and instead of a preheat flame it uses inert gas to prevent weld oxidation. Like oxy flame welding, the filler metal is fed into the weld by hand as required. Due to the fact that the current is not conducted to the job via the filler metal, (as it is in MIG and MMA welding), the arc is much more controllable.

10.2.2.3 Advantages

Very low amperages can be achieved making this process ideal for welding thin materials. Also, due to the independence of the arc and the filler metal application, TIG welding is very controllable and can therefore achieve very high quality welds with excellent appearance. Unlike MIG and MMA welding, TIG welding does not produce spatter so clean up is very minimal. It is typically used where weld appearance is critical (e.g. handrails) or where weld quality is vital (e.g. pressure vessels or pipes).

10.2.2.4 Limitations

Whilst TIG welding is very controllable, it can also be slower and more tedious than MIG or MMA welding and it will generally not operate well on dirty or rusty materials meaning that additional weld preparation is sometimes necessary. It also requires a higher level of skill and experience to achieve a quality result.

10.2.2.5 Materials

This machine incorporates DC TIG function which can be used to weld a variety of materials including mild steels, stainless steels, copper and chrome moly.

Note: TIG welding is often associated with welding of aluminium, however, aluminium TIG welding is only possible with AC/DC TIG welding machines. This machine is DC only and is not designed for TIG welding of aluminium.

10.2.3 The MIG Process

10.2.3.1 Description

The acronym MIG stands for Metal Inert Gas. Metal' refers to the fact that the filler metal itself (the MIG wire) is used to conduct the welding current to the job and create the arc. Inert Gas refers to the fact that the process relies on an inert gas to prevent weld oxidation. The acronym MAG is also often used which stands for Metal Active Gas. MAG is fundamentally the same as MIG except that MAG technically refers to when Carbon Dioxide (CO₂) is used as a shielding gas (instead of an inert gas of argon, helium or a mixed gas with these as a base).

The process is also referred to as Gas Metal Arc Welding (GMAW) when gas is used or Flux-Cored Arc Welding (FCAW) when flux-cored or gasless/self-shielded wire is used.

10.2.3.2 Process

The MIG welding process involves the filler wire being fed through a torch/gun to the job. The filler wire carries the welding current to the job. The weld pool is generally covered by an inert gas supplied from the torch which shields the weld and prevents it from oxidising. However, gasless welding wire can be used without any shielding gas. This gasless wire has a hollow core filled with flux which shields the weld and prevents it from oxidising. During welding this flux forms into a slag covering the weld which is chipped off after the weld has formed.

10.2.3.3 Advantages

MIG welding is both easy and fast. Once weld settings are adjusted, the filler wire is fed automatically into the weld at the correct rate. It does not rely on the operator to feed in filler wire like TIG welding. Also because the filler wire is on a roll it lasts significantly longer than a Stick welding electrode so

there is much less downtime in replacing filler wire. MIG can also weld with thin wires at low amperages achieving great results on thin materials. At the same time, bigger diameter wires and higher amperages can be used to weld thicker materials with good penetration. When a shielding gas is used there is no flux formed on the weld so clean up is minimal.

10.2.3.4 Limitations

MIG welding with shielding gas cannot be done in windy environments. However, in many applications gasless/self-shielding wires are available that don't require gas. MIG traditionally requires a higher level of skill and experience to be able to balance voltage and wire speed settings well to achieve a quality result. However, the Synergic programs on this machine make this this very easy and much more foolproof.

10.2.3.5 Materials

MIG welding can be used with a wide variety of wires including steel, stainless steel, gasless wires, aluminium, silicone bronze & hard facing just to name a few.

10.3 Joint Preparations

In many cases, it will be possible to weld steel sections without any special preparation. For heavier sections and for repair work on castings, etc., it will be necessary to cut or grind an angle between the pieces being joined to ensure proper penetration of the weld metal and to produce sound joints. In general, surfaces being welded should be clean and free of rust, scale, dirt, grease, etc. Slag should be removed from oxy-cut surfaces. Typical joint designs are shown in the following figures.

Open Square Butt Joint

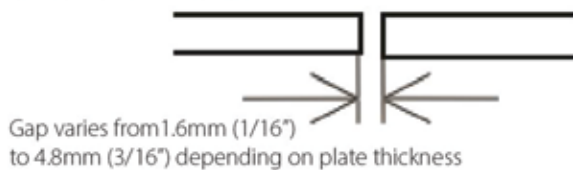

Figure 3

Single Vee Butt Joint

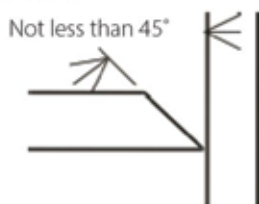

Figure 4

Single Vee Butt Joint

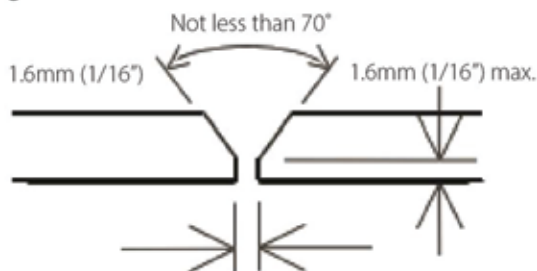

Figure 5

Double Vee Butt Joint

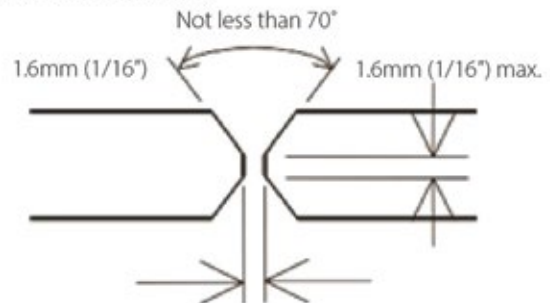

Figure 6

Lap Joint



Figure 7

Fillet Joint

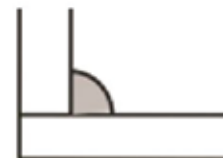

Figure 8

Tee Joints

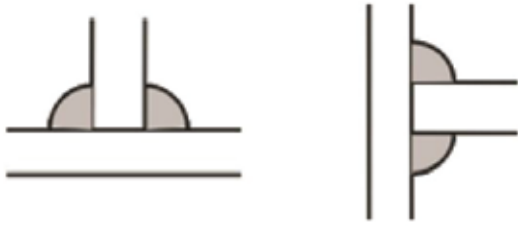

Figure 9

Edge Joint



Figure 10

Corner Weld



Figure 11

Plug Welds



Figure 12

1 1 MIG BASIC WELDING GUIDE

11.1 MIG Basic Welding Techniques

Two different welding processes are covered in this section (GMAW and FCAW), with the intention of providing the very basic concepts in MIG welding, where a welding torch is hand held, and the electrode (welding wire) is fed into a weld pool, and the arc is shielded by a gas (GMAW) or flux cored wire (FCAW).

11.2 Gas Metal Arc Welding (GMAW)

This process, also known as MIG welding, CO₂ welding, Micro Wire Welding, short arc welding, dip transfer welding, wire welding etc. It is an electric arc welding process which fuses together the parts to be welded by heating them with an arc between a solid continuous, consumable electrode and the work. Shielding is obtained from an externally supplied welding grade shielding gas. The process is normally applied semi automatically; however the process may be operated automatically and can be machine operated. The process can be used to weld thin and fairly thick steels and some nonferrous metals in all positions.

GMAW Process

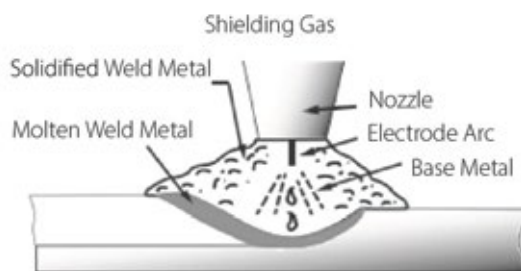

Figure 13

11.3 Flux Cored Arc Welding (FCAW)

This is an electric arc welding process which fuses together the parts to be welded by heating them with an arc between a continuous flux-filled welding wire and the work. Shielding is obtained through decomposition of the flux within the tubular wire. Additional shielding may or may not be obtained from an externally supplied gas or gas mixture. The process is normally applied semi automatically; however the process may be applied automatically or by machine. It is commonly used to weld large diameter wires in the flat and horizontal position and small wire diameters in all positions. The process is used to a lesser degree for welding stainless steel and for overlay work.

FCAW Process

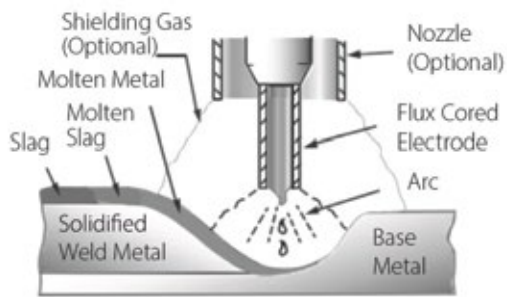

Figure 14

11.4 Position of MIG Torch

The angle of MIG torch to the weld has an effect on the width of the weld. The welding torch should be held at an angle to the weld joint. (See Secondary Adjustable Variables below). Hold the torch so that the welding seam is viewed at all times. Always wear the welding helmet with proper filter lenses and use the proper safety equipment.

CAUTION! Do not pull the welding torch back when the arc is established. This will create excessive wire extension (stick-out) and make a very poor weld.

The welding wire is not energized until the torch trigger switch is depressed. The wire may therefore be placed on the seam or joint prior to lowering the helmet.

Position of MIG Torch

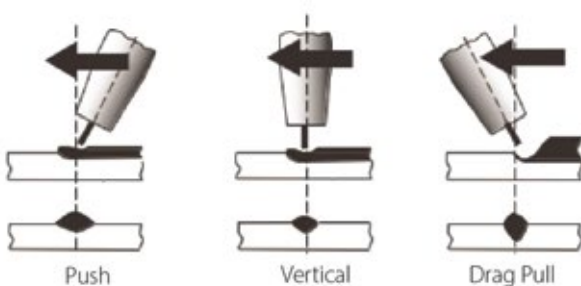

Figure 15

11.5 Distance from the MIG Torch Nozzle to the Work Piece

The welding wire stick out from the MIG Torch nozzle should be between 10mm to 20mm. This distance may vary depending on the type of joint and type of wire that is being welded. Generally solid wire is about 10mm and flux-cored/gasless wire about 15-20mm.

11.6 Travel Speed

The speed at which the molten pool travels influences the width of the weld and penetration of the welding run.

11.7 MIG Welding (GMAW) Variables

Most of the welding done by all processes is on carbon steel. The items below describe the welding variables in short-arc welding of 0.6mm to 6mm mild sheet or plate. The applied techniques and end results in the MIG process are controlled by these variables.

11.7.1 Preselected Variables

Preselected variables depend upon the type of material being welded, the thickness of the material, the welding position, the deposition rate and the mechanical properties.

These variables are:

1. Type of welding wire
2. Size of welding wire
3. Type of shielding gas
4. Gas flow rate

11.7.2 Primary Adjustable Variables

These control the process after preselected variables have been found. They control the penetration, bead width, bead height, arc stability, deposition rate and weld soundness.

These variables are:

1. Arc Voltage
2. Welding current (wire feed speed)
3. Travel speed

11.7.3 Secondary Adjustable Variables

These variables cause changes in primary adjustable variables which in turn cause the desired change in the bead formation. They are:

1. **Stick-Out:** This is the distance between the end of the contact tube (tip) and the end of the welding wire). Maintain at about 10mm stick-out for solid wire and 15-20mm for gasless wire.

Electrode Stick-Out

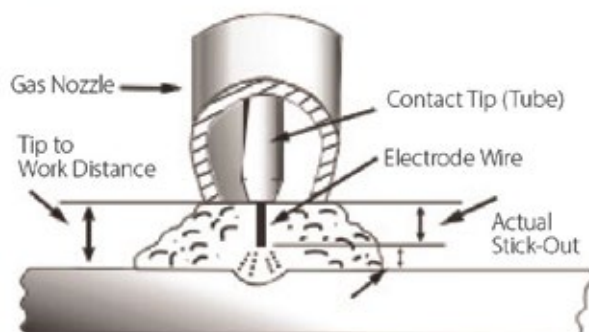

Figure 16

2. **Wire Feed Speed:** Increase in wire feed speed increases weld current/ampereage. Decrease in wire feed speed decreases weld current.

3. **Nozzle Angle:** This refers to the position of the welding torch in relation to the joint. The transverse angle is usually one half the included angle between plates forming the joint. The longitudinal angle is the angle between the centre line of the welding torch and a line perpendicular to the axis of the weld. The longitudinal angle is generally called the Nozzle Angle and can be either trailing (pulling) or leading (pushing). Whether the operator is left handed or right handed has to be considered to realize the effects of each angle in relation to the direction of travel.

Transverse & Longitudinal Nozzle Axes

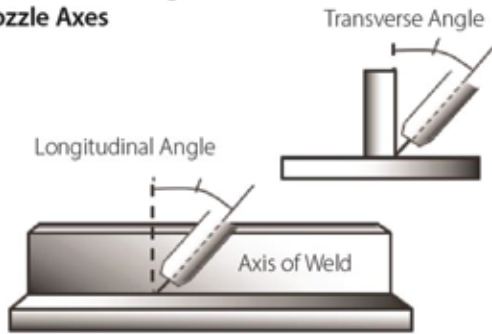

Figure 17

Nozzle Angle, Right Handed Operator

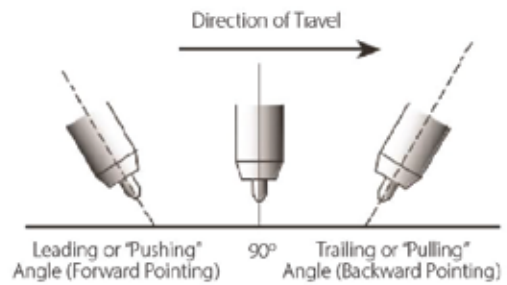

Figure 18

Horizontal Butt Weld

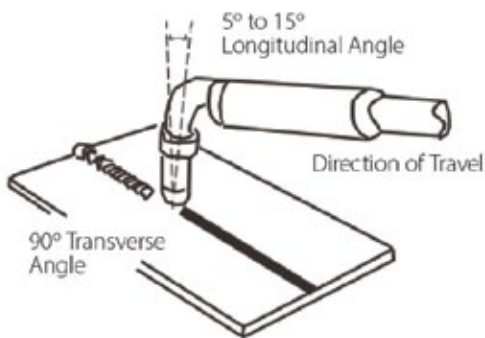

Figure 19

Vertical Fillet Welds

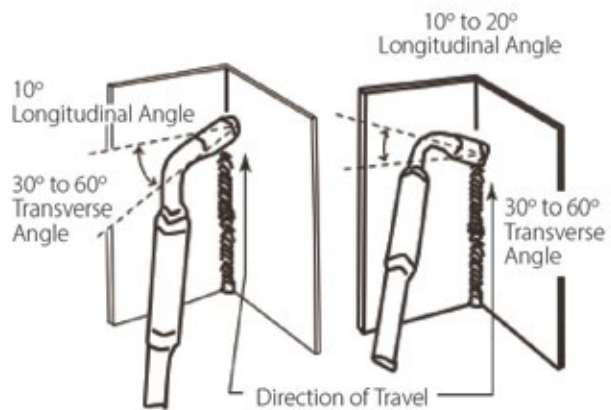

Figure 21

Horizontal Fillet Weld

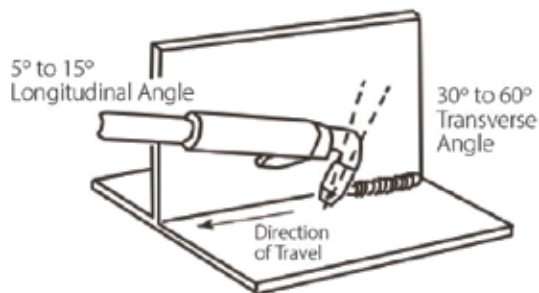

Figure 20

Overhead Fillet Weld

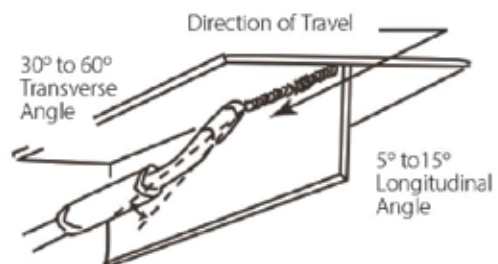

Figure 22

11.8 Establishing the Arc and Making Weld Beads

Before attempting to weld on a finished piece of work, it is recommended that practice welds be made on a sample metal of the same material as that of the finished piece. The easiest welding procedure for the beginner to experiment with MIG welding is the flat position. The equipment is capable of flat, vertical and overhead positions. For practicing MIG welding, secure some pieces of 1.6mm or 2.0mm mild steel plate (150 x 150mm). Use 0.9mm flux cored gasless wire or a solid wire with shielding gas.

11.9 MIG Voltage & Wire Speed Settings

Manual MIG welding setting requires some practice by the operator, as the machine has two control settings that have to balance. These are the Wire Speed control and the welding Voltage control.

Voltage is essentially the power in the welding arc that sets the heat. The wire speed feed simply controls the rate at which the welding wire is fed into the weld pool. For any voltage position setting, there will be a specific corresponding 'sweet spot' in the wire feeding speed that will give the smoothest and most stable welding arc. The correct wire feeding speed for a given voltage setting is affected by welding wire type and size, shielding gas, welding material and joint type.

The recommended process for setting a MIG in Manual mode (where/if this option is available) is:

1. Set the welding voltage as desired
2. Slowly adjust the wire speed until the arc is smooth and stable.
3. When reaching this point, if the penetration/ heat input is too much/ not enough, adjust the voltage setting and repeat the process.
4. If not able to achieve a smooth and stable arc with the desired heat input for the weld, it is likely that a change in wire size and/or shielding gas type is required (assuming all other factors are correct).

The process for setting a MIG in 'Synergic' mode (where/if this option is available) is:

1. Choose Synergic program/settings to suit wire type, wire size, and shielding gas type
2. Select amperage output or material thickness
3. The machine calculates the optimal voltage and wire speed for the application
4. Obviously other variables such as welding joint type, position and thickness, air temperature can affect the optimal voltage and wire feed setting, so voltage can be adjusted to fine-tune for optimal performance.

11.9.1 Setting Wire Speed/Amperage

The welding current (amperage) is determined by the Wire Speed control. Increased Wire Speed will increase the current and result in a shorter arc. Less Wire Speed will reduce the current and lengthen the arc.

11.9.2 Setting Voltage

Increasing the welding voltage hardly alters the current level, but lengthens the arc. By decreasing the voltage, a shorter arc is obtained with a little change in current level.

11.9.3 Changing to a different welding wire

When changing to a different welding wire diameter, different control settings are required. A thinner welding wire needs more Current (Wire Speed) to achieve the same current level. A satisfactory weld cannot be obtained if the Current (Wire Speed) and Voltage settings are not adjusted to suit the welding wire diameter and the dimensions of the work piece.

11.9.4 How to determine correct Wire Speed/Voltage Setting

If the Current/Amperage (Wire Speed) is too high for the welding voltage, “stubby” will occur as the wire dips into the molten pool and does not melt. Welding in these conditions normally produces a poor weld due to lack of fusion.

If, however, the welding voltage is too high, large drops will form on the end of the wire, causing spatter. The correct setting of voltage and Current (Wire Speed) can be seen in the shape of the weld deposit and heard by a smooth regular arc sound.

11.10 Suggested Settings for Typical MIG Applications

Material	Wire Type	Shielding Gas	Wire Size	Weld Position	Amperage Range	Voltage Range
Mild Steel	Solid Mild Steel (E70S-6)	Argon + CO ² Mix	0.6mm	All	50 – 80	18 – 20
			0.8mm	All	60 – 220	16 – 22
			0.9mm	All	120 – 350	15 – 23
	Gasless Flux-cored Mild Steel (E71T-11)	Not required	0.8mm	Horizontal	90 – 150	14 – 16
				Vertical & Overhead	60 – 125	10 – 12
			0.9mm	Horizontal	80 – 200	12 – 17
				Vertical & Overhead	70 – 150	12 – 15
			1.2mm	Horizontal	160 – 220	16 – 18
Vertical & Overhead	120 – 180	16 – 18				
Stainless Steel	Stainless Steel 316L	Argon or Mix	0.8mm	All	60 – 125	17 – 22
			0.9mm	All	75 – 160	17 – 22
Aluminium	Aluminium (5356)	Argon	1.0mm	All	170 – 200	19 – 21

Table 2

These settings are a guide only. Actual settings required will depend on plate thickness, operator technique, environment, etc. Available settings may vary between different machine models.

11.11 Welding wire Size Selection

The choice of Welding wire size and shielding gas used depends on the following:

1. Thickness of the metal to be welded
2. Type of joint
3. Capacity of the wire feed unit and power source
4. The amount of penetration required
5. The deposition rate required
6. The bead profile desired
7. The position of welding
8. Cost of the wire
9. Environment (can shielding gas be used or not?)

11.12 MIG Welding Troubleshooting

The general approach to fix MIG welding problems is to start at the wire spool then work through to the MIG torch. There are two main areas where problems occur with MIG: Porosity and Inconsistent wire feed.

11.12.1 Porosity Problems

When there is a gas problem the result is usually porosity within the weld metal. Porosity always stems from some contaminant within the molten weld pool which is in the process of escaping during solidification of the molten metal.

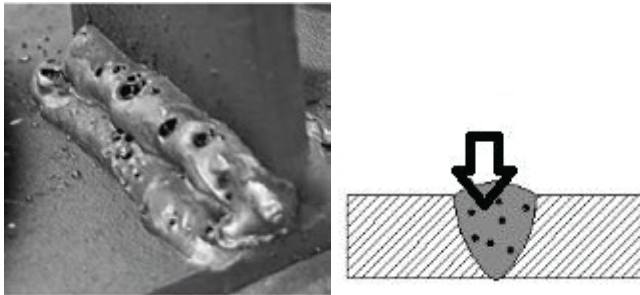

Figure 23

Contaminants range from no gas around the welding arc to dirt on the workpiece surface. Porosity can be reduced by checking the following points.

Troubleshooting - Porosity	
Fault	Cause
Shielding gas cylinder contents and gas regulator	Ensure that the shielding gas cylinder is not empty and the gas regulator is correctly adjusted to at least 15 litres per minute
Gas leaks	Check for gas leaks between the regulator/cylinder connection and in the gas hose to the Power Source.
Internal gas hose in the Power Source	Ensure the hose from the solenoid valve to the torch adaptor has not fractured and that it is connected to the torch adaptor. This should only be done by qualified technician.
Welding in a windy environment	Shield the weld area from the wind or increase the gas flow or use gasless welding wire
Welding dirty, oily, painted, oxidized or greasy plate	Clean contaminates off the work piece.
Distance between the MIG torch nozzle and the work piece	Keep the distance between the MIG torch nozzle and the work piece to a minimum.
Maintain the MIG torch in good working order.	Ensure that the gas holes are not blocked in the tip holder and gas is exiting out of the torch nozzle.
	Do not restrict gas flow by allowing spatter to build up inside the torch nozzle.
	Check that the MIG torch O-rings are not damaged on the Euro connector.

Table 3

WARNING! Disengage the feed roll when testing for gas flow by ear

11.12.2 Wire Feed Problems

TOP TIPS - Wire Jam Troubleshooting
<p>If wire jam occurs when the torch becomes hot, this is often because the heat causes the wire and the top to expand (which shrinks the hole in the tip). Using a slightly oversize tip can prevent this – eg: for 0.9mm wire, use a 1.0mm tip.</p> <p>Do NOT over-tighten the drive roll tension – this will accelerate wear if the drive system, distort the wire & will cause further wire feed problems.</p>

Table 4



Wire feeding problems can be reduced by checking the following points.
The most common faults are marked with *:

Troubleshooting – Wire Feed	
Fault	Cause
Feed roller driven by motor in the cabinet slipping	Wire spool brake is too tight.
Wire spool unwound and tangled.	Wire spool brake is too loose.
Worn or incorrect feed roller size	Use a feed roller matched to the size you are welding.
	Replace feed roller if worn.
Wire rubbed against the misaligned guides affecting the wire feed.	Misalignment of inlet/outlet guides.
* Liner blocked with swarf (Replace liner)	Increased amounts of swarf are produced by the wire passing through the feed roller when excessive pressure is applied to the pressure roller adjuster.
	Swarf can also be produced by the wire passing through an incorrect feed roller groove shape or size.
	Swarf is fed into the conduit liner where it accumulates thus reducing wire feed.
* Incorrect or worn contact tip	The contact tip transfers the weld current to the electrode wire. If the hole in the contact tip is too large then arcing may occur inside the contact tip resulting in the wire jamming in the contact tip.
	When using soft wire such as aluminum it may become jammed in the contact tip due to expansion of the wire when heated. A contact tip designed for soft wires should be used.
Poor work lead contact to work piece.	If the work lead has a poor electrical contact to the work piece then the connection point will heat up and results in reduction of power at the arc.
Bent liner (Replace liner)	This will cause friction between the wire and the liner this reducing wire feed.

Table 5

11.12.3 Weld Quality Problems

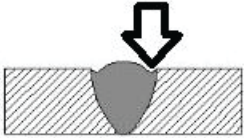
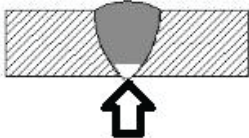
Other weld problems can be reduced by checking the following points.

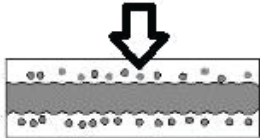
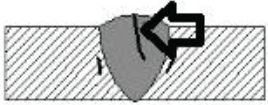
Troubleshooting – MIG Weld Quality		
Fault	Cause	Remedy
Undercut  Figure 24	Welding arc voltage too high	Decrease voltage or increase the wire feed speed.
	Incorrect torch angle	Adjust angle.
	Excessive heat input	Increase the torch travel speed and/or decrease welding current by decreasing the voltage or decreasing the wire feed speed.
Lack of penetration  Figure 25	Welding current too low.	Increase welding current by increasing wire feed speed and increasing voltage.
	Joint preparation too narrow or gap too tight.	Increase joint angle or gap.
	Shielding gas incorrect.	Change to a gas which gives higher penetration.
Lack of fusion  Figure 26	Voltage too low	Increase voltage
Excessive spatter  Figure 27	Voltage too high	Decrease voltage or increase the Current (Wire Speed) control/
	Voltage too low.	Increase the voltage or decrease Current (Wire Speed)
Irregular weld shape	Incorrect voltage and current settings. Convex, voltage too low. Concave, voltage too high.	Adjust voltage and current by adjusting the voltage control and the Current (Wire Speed) control
	Wire is wandering.	Replace contact tip.
	Incorrect shielding gas.	Check shielding gas.
	Insufficient or excessive heat input.	Adjust the Current (Wire Speed) control or the voltage control.
Weld cracking  Figure 28	Weld bead is too small.	Decrease travel speed.
	Weld penetration narrow and deep.	Reduce current and voltage and increase MIG torch travel speed or select a lower penetration shielding gas.
	Excessive weld stresses.	Increase weld metal strength or revise design.
	Excessive voltage.	Decrease voltage.
	Cooling rate too fast.	Slow the cooling rate by preheating part to be welded or cool slowly.

Troubleshooting – MIG Weld Quality		
Fault	Cause	Remedy
Cold weld puddle	Loose welding cable connection.	Check all welding cable connections
	Low power supply voltage.	Contact supply authority
Arc does not have a crisp sound that short arc exhibits when the wire feed speed and voltage are adjusted correctly	The MIG torch has been connected to the wrong voltage polarity on the front panel.	Connect the MIG torch to the positive (+) welding terminal for solid wires and negative (-) welding terminal for gasless wires. Refer to the wire manufacturer for the correct polarity.

Table 6

12 STICK (MMA) BASIC WELDING GUIDE

12.1 Size of Electrodes

The electrode size is determined by the thickness of metals being joined and can also be governed by the type of welding machine available. Small welding machines will only provide current (amperage) to run smaller sized electrodes. For thin sections, it is necessary to use smaller electrodes otherwise the arc may burn holes through the job. A little practice will soon establish the most suitable electrode for a given application.

12.2 Storage of Electrodes

Always store electrodes in a dry place and in their original containers. If electrodes have been exposed to moisture or moist air then they will need to be dried out using an electrode drying oven.

12.3 Electrode Polarity

Electrodes are generally connected to the electrode holder with the electrode holder connected positive polarity.

The work lead is connected to the negative polarity and is connected to the work piece. If in doubt consult the electrode supplier's recommendations.

12.4 Effects of Stick (MMA) Welding on Various Materials

12.4.1 High Tensile and Alloy Steels

The two most prominent effects of welding these steels are the formation of a hardened zone in the weld area, and, if suitable precautions are not taken, the occurrence in this zone of under-bead cracks. Hardened zone and under-bead cracks in the weld area may be reduced by using the correct electrodes, preheating, using higher current settings, using larger electrodes sizes, short runs for larger electrode deposits or tempering in a furnace.

12.4.2 Manganese Steels

The effect on manganese steel of slow cooling from high temperatures causes embrittlement. For this reason it is absolutely essential to keep manganese steel cool during welding by quenching after each weld or skip welding to distribute the heat.

12.4.3 Cast Iron

Most types of cast iron, except white iron, are weldable. White iron, because of its extreme brittleness, generally cracks when attempts are made to weld it. Trouble may also be experienced when welding white-heart malleable, due to the porosity caused by gas held in this type of iron.

12.5 Types of Electrodes

Arc Welding electrodes are classified into a number of groups depending on their applications. There are a great number of electrodes used for specialised industrial purposes which are not of particular interest for everyday general work. These include some low hydrogen types for high tensile steel, cellulose types for welding large diameter pipes, etc. The range of electrodes dealt with in this publication will cover the vast majority of applications likely to be encountered; are all easy to use.

12.5.1 MILD STEEL:

- 1. General Purpose "GP" E6013:** This all-position electrode is used for maintenance and fabrication. Works well on mild steel, galvanized steel, sheet metal, steel tube and RHS. Its soft arc has minimal spatter, moderate penetration and an easy-to-clean slag. Tolerant to dirty / rusty steel & poor fit up. This is the most common type of electrode used for Stick welding.
- 2. Low Hydrogen E7018:** A "low-hydrogen" electrode commonly used for mild or high strength steel, where the joint requires higher strength than regular "GP" electrodes, such as highly restrained joints or components subject to higher load stress. Also used as a buffer layer prior to hard facing. All-Positional (except for vertical down), easy striking & smooth running, with low spatter & easy slag removal.

12.5.2 CAST IRON:

- 1. Cast Iron Ni-Fe:** Suitable for joining all cast irons (Suitable for mehanite, alloy and malleable cast iron) except white cast iron. Weld positions : flat, horizontal.

12.5.3 STAINLESS STEEL:

- 1. Stainless Steel 316L:** Used for welding common 300 series stainless steels such as 301, 302, 304, 304L and 316L. All welding positions, excluding vertical down. Very Smooth Running and Easy to use.
- 2. Weld-All:** Weld-all style electrodes for welding almost any steel or stainless-steel, including dissimilar metals. Weld metal is very crack resistant. Commonly used for repair and maintenance welding of unknown steels. All welding positions excluding vertical down.

12.6 Suggested Settings for Typical Stick (MMA) Applications

Electrode Type	Part Number	Electrode Size	Amperage Range
General Purpose (E6013)	WEL1KG-16	1.6mm	20-45A
	WEL1KG-20	2.0mm	30-65A
	WEL1KG-25	2.5mm	60-95A
	WEL1KG-32	3.2mm	90-130A

Low Hydrogen E7018	WEL7018-32	3.2mm	80-140A
Cast Iron Ni-Fe	WELCI-25	2.5mm	50-80A
	WELCI-32	3.2mm	70-110A
Stainless Steel 316L	WEL316-25	2.5mm	40-80A
	WEL316-32	3.2mm	60-130A
Weld-All 312	WEL312-25	2.5mm	45-80A
	WEL312-32	3.2mm	65-110A
Hard-Facing HF600	WELHF-32	3.2mm	90-130A
	WELHF-40	4.0mm	120-180A

Table 7

These settings are a guide only. Actual settings required will depend on plate thickness, operator technique, environment, etc. Available settings may vary between different machine models.

12.7 MMA Welding Techniques

12.7.1 A Word for Beginners

For those who have not yet done any welding, the simplest way to commence is to run beads on a piece of scrap plate. Use mild steel plate about 6.0mm thick and a 3.2mm electrode.

Clean any paint, loose scale or grease off the plate and set it firmly on the work bench so that welding can be carried out in the down hand position. Make sure that the Work Lead/Clamp is making good electrical contact with the work, either directly or through the work table. For light gauge material, always clamp the work lead directly to the job, otherwise a poor circuit will probably result.

12.7.2 The Welder

Place yourself in a comfortable position before beginning to weld. Get a seat of suitable height and do as much work as possible sitting down. Don't hold your body tense. A taut attitude of mind and a tensed body will soon make you feel tired. Relax and you will find that the job becomes much easier. You can add much to your peace of mind by wearing a leather apron and gauntlets. You won't be worrying then about being burnt or sparks setting alight to your clothes.

Place the work so that the direction of welding is across, rather than to or from, your body. The electrode holder lead should be clear of any obstruction so that you can move your arm freely along as the electrode burns down. If the lead is slung over your shoulder, it allows greater freedom of movement and takes a lot of weight off your hand. Be sure the insulation on your cable and electrode holder is not faulty; otherwise you are risking an electric shock.

12.7.3 Striking the Arc

Practice this on a piece of scrap plate before going on to more exacting work.

You may at first experience difficulty due to the tip of the electrode "sticking" to the work piece. This is caused by making too heavy a contact with the work and failing to withdraw the electrode quickly enough. A low amperage will accentuate it. This freezing on of the tip may be overcome by scratching the electrode along the plate surface in the same way as a match is struck.

Another difficulty you may meet is the tendency, after the arc is struck, to withdraw the electrode so far that the arc is broken again. A little practice will soon remedy both of these faults.

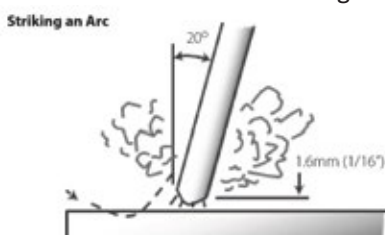

Figure 29

12.7.4 Arc Length

As soon as the arc is established, maintain a 1.6mm to 3.2mm gap between the burning electrode end and the parent metal. Draw the electrode slowly along as it melts down. The securing of an arc length necessary to produce a neat weld soon becomes almost automatic. You will find that a long arc produces more heat.

A very long arc produces a crackling or spluttering noise and the weld metal comes across in large, irregular blobs. The weld bead is flattened and spatter increases. A short arc is essential if a high quality weld is to be obtained although if it is too short there is the danger of it being blanketed by slag and the electrode tip being solidified in. If this should happen, give the electrode a quick twist back over the weld to detach it.

12.7.5 Rate of Travel

After the arc is struck, your next concern is to maintain it, and this requires moving the electrode tip towards the molten pool at the same rate as it is melting away. At the same time, the electrode has to move along the plate to form a bead.

The electrode is directed at the weld pool at about 20° from the vertical. The rate of travel has to be adjusted so that a well-formed bead is produced.

If the travel is too fast, the bead will be narrow and strung out and may even be broken up into individual globules. If the travel is too slow, the weld metal piles up and the bead will be too large.

12.8 Making Welded Joints

Having attained some skill in the handling of an electrode, you will be ready to go on to make up welded joints.

12.8.1 Butt Welds

Set up two plates with their edges parallel, as shown in Figure 30, allowing 1.6mm to 2.4mm gap between them and tack weld at both ends. This is to prevent contraction stresses from the cooling weld metal pulling the plates out of alignment.

Plates thicker than 6.0mm should have their mating edges beveled to form a 70° to 90° included angle. This allows full penetration of the weld metal to the root. Using a 3.2mm Weldclass 12V Stick electrode at 100 amps, deposit a run of weld metal on the bottom of the joint.

Do not weave the electrode, but maintain a steady rate of travel along the joint sufficient to produce a well-formed bead. At first you may notice a tendency for undercut to form, but keeping the arc length short, the angle of the electrode at about 20° from vertical, and the rate of travel not too fast, will help eliminate this.

The electrode needs to be moved along fast enough to prevent the slag pool from getting ahead of the arc. To complete the joint in thin plate, turn the job over, clean the slag out of the back and deposit a similar weld.

Heavy plate will require several runs to complete the joint. After completing the first run, chip the slag out and clean the weld with a wire brush. It is important to do this to prevent slag being trapped by the second run. Subsequent runs are then deposited using either a weave technique or single beads laid down in the sequence shown in Figure 31. The width of weave should not be more than three times the core wire diameter of the electrode.

When the joint is completely filled, the back is either machined, ground or gouged out to remove slag which may be trapped in the root, and to prepare a suitable joint for depositing the backing run. If a backing bar is used, it is not usually necessary to remove this, since it serves a similar purpose to the

backing run in securing proper fusion at the root of the weld.

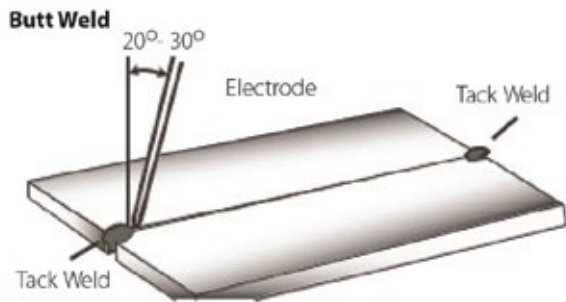

Figure 30

Weld Build Up Sequence

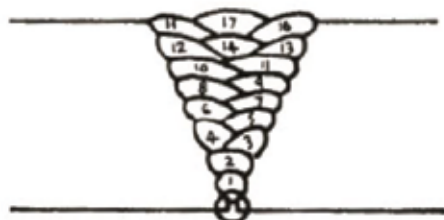

Figure 31

12.8.2 Fillet Welds

These are welds of approximately triangular cross-section made by depositing metal in the corner of two faces meeting at right angles. Refer Figure 32 and Figure 33.

A piece of angle iron is a suitable specimen with which to begin, or two lengths of strip steel may be tacked together at right angles. Using a 3.2mm Weldclass 12V Stick electrode at 100 amps, position angle iron with one leg horizontal and the other vertical. This is known as a horizontal-vertical (HV) fillet. Strike the arc and immediately bring the electrode to a position perpendicular to the line of the fillet and about 45° from the vertical. Some electrodes require being sloped about 20° away from the perpendicular position to prevent slag from running ahead of the weld. Refer to Figure 32.

Do not attempt to build up much larger than 6.4mm width with a 3.2mm electrode, otherwise the weld metal tends to sag towards the base, and undercut forms on the vertical leg. Multi-runs can be made as shown in Figure below. Weaving in HV fillet welds is undesirable.

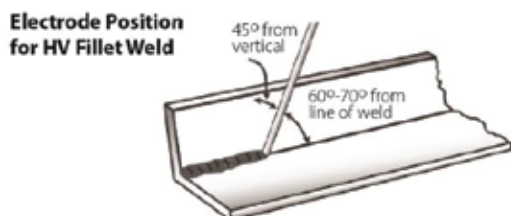

Figure 32



Figure 33

12.8.3 Vertical Welds

12.8.3.1 Vertical Up

Tack weld a three feet length of angle iron to your work bench in an upright position. Use a 3.2mm Weldclass 12V Stick electrode and set the current at 100 amps. Make yourself comfortable on a seat in front of the job and strike the arc in the corner of the fillet. The electrode needs to be about 10° from the horizontal to enable a good bead to be deposited.

Refer Figure 34.

Single Run Vertical Fillet Weld

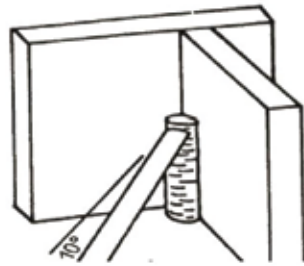

Figure 34

Use a short arc, and do not attempt to weave on the first run. When the first run has been completed deslag the weld deposit and begin the second run at the bottom. This time a slight weaving motion is necessary to cover the first run and obtain good fusion at the edges.

At the completion of each side motion, pause for a moment to allow weld metal to build up at the edges, otherwise undercut will form and too much metal will accumulate in the centre of the weld. Figure 35 illustrates multi-run technique and Figure 36 shows the effects of pausing at the edge of weave and of weaving too rapidly.

Multi Run Vertical Fillet Weld

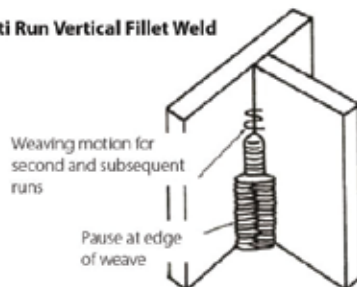

Figure 35

Examples of Vertical Fillet Welds

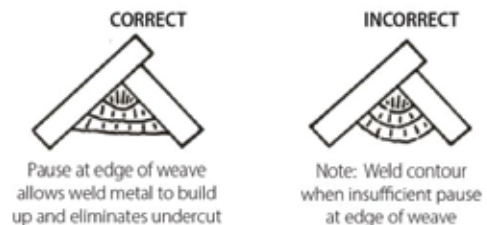

Figure 36

12.8.3.2 Vertical Down

The Weldclass 12V Stick electrode makes welding in this position particularly easy. Use a 3.2mm

electrode at 100 amps. The tip of the electrode is held in light contact with the work and the speed of downward travel is regulated so that the tip of the electrode just keeps ahead of the slag. The electrode should point upwards at an angle of about 45°.

12.8.4 Overhead Welds

Apart from the rather awkward position necessary, overhead welding is not much more difficult than down hand welding. Set up a specimen for overhead welding by first tacking a length of angle iron at right angles to another piece of waste pipe. Then tack this to the work bench or hold in a vice so that the specimen is positioned in the overhead position as shown in the sketch.

The electrode is held at 45° to the horizontal and tilted 10° in the line of travel (Figure 37). The tip of the electrode may be touched lightly on the metal, which helps to give a steady run. A weave technique is not advisable for overhead fillet welds.

Use a 3.2mm Weldclass 12V Stick electrode at 100 amps, and deposit the first run by simply drawing the electrode along at a steady rate. You will notice that the weld deposit is rather convex, due to the effect of gravity before the metal freezes.

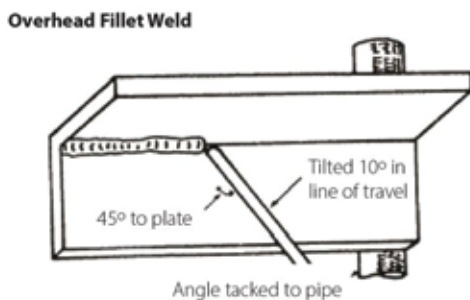
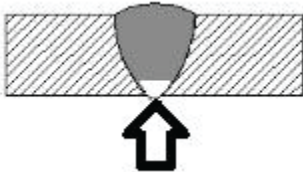
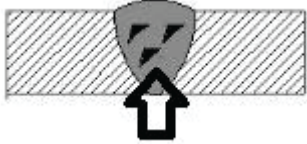
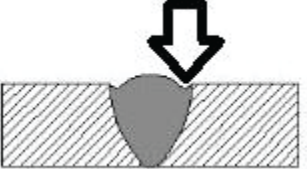

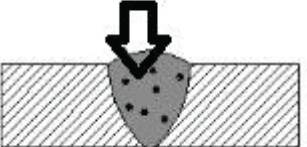

Figure 37

12.9 MMA (Stick) Troubleshooting

Fault	Cause	Remedy
A gap is left by failure of the weld metal to fill the root of the weld. 	Welding current too low.	Increase welding current.
	Electrode too large for joint.	Use smaller diameter electrode.
	Insufficient gap.	Allow wider gap.
Non-metallic particles are trapped in the weld metal. Figure 38	Non-metallic particles may be trapped in undercut from previous run.	If a bad undercut is present clean slag out and cover with a run from a smaller gauge electrode.
	Joint preparation too restricted.	Allow for adequate penetration and room for cleaning out the slag.
	Irregular deposits allow slag to	If very bad, chip or grind out

Fault	Cause	Remedy
 <p data-bbox="300 398 392 421">Figure 39</p>	be trapped.	irregularities.
	Lack of penetrations with slag trapped beneath weld bead.	Use smaller electrode with sufficient current to give adequate penetrations. Use suitable tools to remove all slag from comers.
	Rust or mill scale or preventing full fusion.	Clean joint before welding.
	Wrong electrode for position in which welding is done.	Use electrodes designed for position in which welding is done, otherwise proper control of slag is difficult.
<p data-bbox="260 656 592 819">A groove has been formed in the base metal adjacent to the top of a weld and has not been filled by the weld metal (undercut).</p>  <p data-bbox="300 1037 392 1059">Figure 40</p>	Welding current is too high.	Reduce welding current.
	Welding arc is too long.	Reduce the length of the welding arc.
	Angle of the electrode is incorrect.	Electrode should not be inclined less than 45° to the vertical face.
	Joint preparation does not allow correct electrode angle.	Allow more room for joint for manipulation of the electrode.
	Electrode too large for joint.	Use smaller gauge electrode.
	Insufficient deposit time at edge of weave.	Pause for a moment at edge of weave to allow weld metal build-up.
	Power source is set for MIG (GMAW) welding.	Set power source to STICK (MMA) mode.
<p data-bbox="260 1279 592 1373">Portions of the weld run do not fuse to the surface of the metal or edge of the joint.</p>  <p data-bbox="300 1514 392 1536">Figure 41</p>	Small electrodes used on heavy cold plate.	Use larger electrodes and preheat the plate.
	Welding current is too low.	Increase welding current.
	Wrong electrode angle.	Adjust angle so the welding arc is directed more into the base metal.
	Travel speed of electrode is too high.	Reduce travel speed of electrode.
	Scale or dirt on joint surface.	Clean surface before welding.
<p data-bbox="260 1601 592 1653">Gas pockets or voids in weld metal (porosity)</p>  <p data-bbox="300 1868 392 1890">Figure 42</p>	High levels of Sulphur in steel.	Use an electrode that is designed for high Sulphur steels.
	Electrodes are damp.	Dry electrodes before use.
	Welding current is too high.	Reduce welding current.
	Surface impurities such as oil, grease, paint, etc.	Clean joint before welding.
	Welding in a windy environment.	Shield the weld area from the wind.
	Electrode damaged i.e. flux coating incomplete.	Discard damaged electrodes and only use electrodes with a complete flux coating.
Crack occurring in weld metal	Rigidity of joint.	Redesign to relieve weld joint

Fault	Cause	Remedy
soon after solidification commences 		of severe or use crack resistance electrodes.
	Insufficient throat thickness.	Travel slightly slower to allow greater build up in throat.
	Weld current is too high.	Decrease welding current.

Figure 43

Table 8

13 TIG BASIC WELDING GUIDE

TIG Welding is a fusion procedure that uses an electric ARC created between an infusible tungsten electrode and base material to be welded. For TIG welding an inert gas must be used (Argon) which protects the welding bead. If filling material is used, it is made up of rods suitable to the material to be welded (steel, stainless steel, copper etc.).

TIG Welding

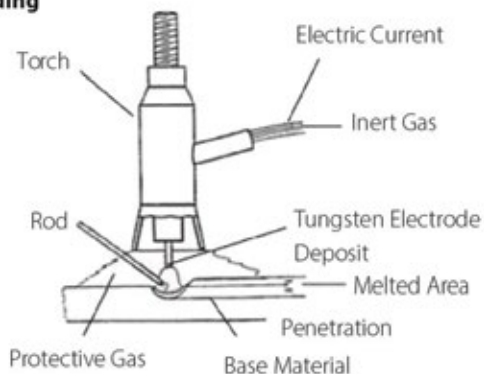

Figure 44

In TIG mode, welding is possible in all positions: flat, angle, on the edge, vertical and overhead. Furthermore, with respect to other types of welding, the welding joint has greater mechanical resistance, greater corrosion resistance and limited heating in the welded area which limits distortion. Welding can be done even without weld material, guaranteeing a smooth, shiny weld with no impurities or slag.

13.1 TIG Electrode Selection and Preparation

13.1.1 Electrode Polarity

Connect the TIG torch to the negative (-) torch terminal and the work lead to the positive (+) work terminal for direct current straight polarity. Direct current straight polarity is the most widely used polarity for DC TIG welding. It allows limited wear of the electrode since 70% of the heat is concentrated at the work piece.

Tungsten Electrode Types			
Electrode Type	Application	Features	Colour Code
Thoriated	Mild Steel, Stainless Steel	High-Performance, suitable for DC (Steel, Stainless steel etc) TIG only	Red

		welding. Maintains tip shape, reliable arc striking, low burn off rate, long service life and smooth/stable arc.	
--	--	--	--

Table 9

* Note that the Weldtech MST140i machine is only capable of DC TIG welding. It cannot perform AC TIG welding required to weld Aluminium.

Tungsten Electrode Current Ranges	
Electrode Diameter	DC Current (Amps)
1.6mm (1/16")	60 – 115
2.4mm (3/32")	100 – 165
3.2mm (1/8")	135 – 200

Table 10

Guide For Selecting Filler Wire Diameter	
Filler Electrode Diameter	DC Current (Amps)
1.6mm (1/16")	20 – 90
2.4mm (3/32")	65 – 115
3.2mm (1/8")	100 – 165

Table 11

13.1.2 Preparing Tungsten for DC Electrode Negative (DCEN) Welding

The electrode should be pointed (tapered) according to the welding current.

Grind end of tungsten on fine grit, hard abrasive wheel before welding. Do not use wheel for other jobs or tungsten can become contaminated causing lower weld quality.

Rule of thumb is that the taper section should be 2.5 times the Electrode Diameter.

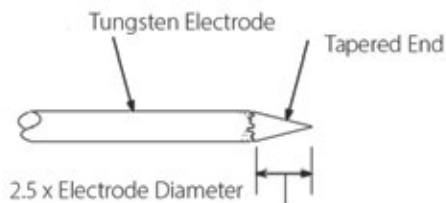

Figure 45

Ideal Tungsten Preparation = Stable ARC

Diameter of the flat left on the end of the Electrode determines amperage capacity.

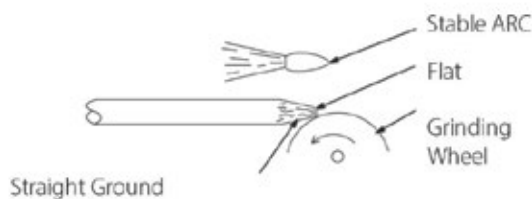

Figure 46

Wrong Tungsten Preparation = Wandering ARC

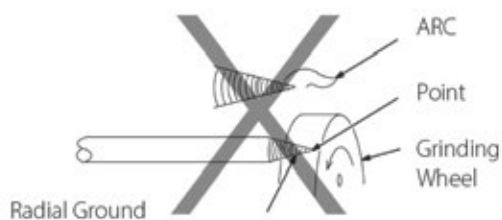

Figure 47

Pointing the Tungsten Electrode

The electrode should be pointed according to the welding current.

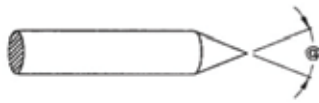

Figure 48

Electrode Angles	
Angle @	Range of Current (Amps)
30°	0 – 30
60-90°	30 -120
90-120°	120 - 250
120°	≥250

Table 12

13.1.3 Shielding Gas for TIG Welding

Shielding Gas Selection	
Alloy	Typical Shielding Gas
Carbon Steel	100% Argon
Stainless Steel	
Nickel Alloy	
Copper	
Titanium	

Table 13

13.1.4 Typical TIG Welding Settings

TIG Welding Settings For Steel						
Metal Thickness	DC Current (Amps)		Tungsten Electrode Diameter	Filler Rod Diameter (if required)	Argon Gas Flow Rate L/min	Joint Type
	Mild Steel	Stainless Steel				
1.2mm (0.045")	45-55	30-45	1.0mm (0.040")	1.6mm (1/16")	5 – 7	Butt/ Corner
	50-60	35-50				Lap / Fillet
1.6mm (1/16")	60-70	40-60	1.6mm (1/16")	1.6mm (1/16")	7	Butt/ Corner
	70-90	50-70				Lap / Fillet
3.2mm (1/8")	80-100	65-85	1.6mm (1/16")	2.4mm (3/32")	7	Butt/ Corner
	90-115	90-110				Lap / Fillet

Table 14

13.2 TIG Welding Troubleshooting

Troubleshooting – TIG Weld quality		
Fault	Cause	Remedy
Excessive bead build up or poor penetration or poor fusion at edges of weld	Welding current is too low.	Increase weld current and/or faulty joint preparation
Weld bead too wide and flat or undercut at edges of weld or excessive burn through	Welding current is too high.	Decrease weld current.
Weld bead too small or insufficient penetration or ripples in bead are widely spaced apart.	Travel speed too fast.	Decrease weld current.
Weld bead too wide or excessive bead build up or excessive penetration in butt joint.	Travel speed too fast.	Increase travel speed.
Uneven leg length in fillet joint	Wrong placement of filler rod.	Re-position rod.
Electrode melts or oxidises when an arc is struck	Torch lead connected to positive welding terminal.	Connect torch lead to negative welding terminal.
	No gas flowing to welding region.	Check the gas lines for kinks or breaks and gas cylinder contents.
	Torch is clogged with dust or dirt.	Clean torch.
	Gas hose is cut.	Replace gas hose.
	Gas passage contains impurities.	Disconnect gas hose from the rear of Power Source then raise gas pressure and blow out impurities.
	Gas regulator turned off.	Turn on.
Dirty weld pool	Torch electrode is too small for the welding current.	Increase electrode diameter or reduce the welding current.
	Electrode contaminated by contact with work piece or filler rod material.	Clean the electrode by grinding off any contaminates.
	Work piece surface has foreign material on it.	Clean surface.
Poor weld pool	Gas contaminated with air.	Check gas lines for cuts and loose fitting or change gas cylinder.
	Inadequate shielding gas.	Increase gas flow or check gas line for gas flow problems.
Arc start is not smooth.	Tungsten electrode is too large for the welding current.	Select the right size electrode.
	The wrong electrode is being used for the welding job.	Select the right electrode type.
	Gas flow rate is too high.	Select the right rate for the welding job.
	Incorrect shielding gas is being used.	Select the right shielding gas.
	Poor Work Lead/Clamp connection to work piece.	Improve connection to work piece.
Arc flutters during TIG welding.	Tungsten electrode is too large for the welding current.	Select the right size electrode.

Table 15

14 SAFETY

14.1 Store and Retain this Manual

Retain this manual for the safety warnings and precautions, assembly, operating, inspection, maintenance and cleaning procedures. Write the product's serial number on the front, and keep this manual and the receipt in a safe and dry place for future reference.

14.2 Important Safety Information

Failure to follow the warnings and instructions may result in electric shock, fire, serious injury and/or death. Save all warnings and instructions for future reference.

This is the safety alert symbol to alert you to potential personal injury hazards:



Obey all safety messages that follow this symbol to avoid possible injury or death.



DANGER! indicates a hazardous situation which, if not avoided, will result in death or serious injury.



WARNING! indicates a hazardous situation which, if not avoided, could result in death or serious injury.



CAUTION, used with the safety alert symbol, indicates a hazardous situation which, if not avoided, could result in minor or moderate injury.

NOTE, used to address practices not related to personal injury.

CAUTION, without the safety alert symbol, is used to address practices not related to personal injury.

14.3 Welding Operation

1. **Maintain labels and nameplates on the welder.** These carry important information. If unreadable or missing, contact Weldclass for a replacement.
2. **Avoid unintentional starting.** Make sure the welder is setup correctly and you are prepared to begin work before turning on the welder.
3. **Unplug before performing maintenance.** Always unplug the welder from its electrical outlet before performing any inspection, maintenance, or cleaning procedures.
4. **Never leave the welder unattended while connected to power supply.** Turn power off before leaving the welder unattended.
5. **Do not touch live electrical parts.** Wear dry, insulating gloves. Do not touch the electrode or the conductor tong with bare hands. Do not wear wet or damaged gloves.

6. **Protect yourself from electric shock.** Do not use the welder outdoors. Insulate yourself from the work piece and the ground. Use non-flammable, dry insulating material if possible, or use dry rubber mats, dry wood or plywood, or other dry insulating material large enough to cover the area of contact with the work or the ground.
7. **Avoid inhaling fume.** Some fume created by welding contain chemicals known to cause cancer, birth defects or other harm. Your risk from these exposures varies, depending on how often you do this type of work. To reduce your exposure to these chemicals, work in a well-ventilated area, and work with approved safety equipment, such as dust masks that are specially designed to filter out microscopic particles.
8. **People with pacemakers should consult their physician(s) before using this machine.**



WARNING! *Electromagnetic fields in close proximity to a heart pacemaker could cause interference, or failure of the pacemaker. The use of a Welder is NOT RECOMMENDED for pacemaker wearers. Consult your doctor.*

9. **Ensure that the unit is placed on a stable location before use.**



WARNING! *If this unit falls while plugged in, severe injury, electric shock, or fire may result.*

10. **Transportation Methods.** Lift unit with the handles provided, or use a handcart or similar device of adequate capacity. If using a fork lift vehicle, secure the unit to a skid before transporting.



CAUTION! *Disconnect input power conductors from de-energized supply line before moving the welding power source.*

11. **Exercise good work practices.** The warnings, precautions, and instructions discussed in this instruction manual cannot cover all possible conditions and situations that may occur. It must be understood by the operator that common sense and caution are factors which cannot be built into this product, but must be considered by the operator.
12. **Do not use this machine for pipe thawing.** This machine was not designed for pipe thawing and will be a significant electrical & heat hazard if attempt is made to use for thawing pipe.

14.4 Welding Safety Instructions & Warnings



WARNING! Protect yourself and others from possible serious injury or death. Keep children away. Read the operating/Instruction manual before installing, operating or servicing this equipment. Have all installation, operation, maintenance, and repair work performed by qualified people.

If an operator does not strictly observe all safety rules and take precautionary actions, welding products and welding processes can cause serious injury or death, or damage to other equipment or property.

Safe practices have developed from past experience in the use of welding and cutting. These practices must be learned through study and training before using this equipment. Some of these practices apply to equipment connected to power lines; other practices apply to engine driven equipment. Anyone not having extensive training in welding and cutting practices should not attempt to weld.

Safe practices are outlined in the Australian Standard AS 1674.2 entitled: Safety in Welding and European Standard EN60974-1 entitled: Safety in welding and allied processes.



WARNING! Only use safety equipment that has been approved by an appropriate standards agency. Unapproved safety equipment may not provide adequate protection. Eye and breathing protection must be AS/NZS compliant for the specific hazards in the work area.



DANGER! Always wear AS/NZS compliant safety glasses and full face shield fitted with appropriate filter shade number. (Refer Filter Table on page 17.)



CAUTION! Heavy-duty work gloves, non-skid safety shoes and hearing protection used for appropriate conditions will reduce personal injuries.



CAUTION! Have the equipment serviced by a qualified repair person using identical replacement parts. This will ensure that the safety of the power tool is maintained.

14.4.1 Personal Safety



CAUTION! *Keep the work area well lit. Make sure there is adequate space surrounding the work area. Always keep the work area free of obstructions, grease, oil, trash, and other debris. Do not use equipment in areas near flammable chemicals, dust, and vapours. Do not use this product in a damp or wet location.*

1. **Stay alert, watch what you are doing and use common sense when operating equipment.** Do not use a tool while you are tired or under the influence of drugs, alcohol or medication. A moment of distraction when operating equipment may result in serious personal injury.
2. **Do not overreach.** Keep proper footing and balance at all times. This enables better control of the power tool in unexpected situations.

14.4.2 Arc Rays can Burn Eyes and Skin



CAUTION! *Arc rays from the welding process produce intense heat and strong ultraviolet rays that can burn eyes and skin.*

1. Use a Welding Helmet or Welding Face Shield fitted with a proper shade filter (refer AS/NZS 60974-1, AS/NZS 1337.1 and AS/NZS 1338.1 Safety Standards) to protect your face and eyes when welding or watching. (See Filter Table on Page17).
2. Wear approved safety glasses. Side shields are recommended.
3. Use protective screens or barriers to protect others from flash and glare; warn others not to watch the arc.
4. Wear protective clothing made from durable, flame-resistant material (wool and leather) and foot safety protection.
5. Never wear contact lenses while welding.

14.4.3 Noise Can Damage Hearing



CAUTION! *Noise from some processes can damage hearing. Use AS/NZS compliant ear plugs or ear muffs if the noise level is high.*

14.4.4 Work Environment Safety



DANGER! Remove any combustible material from the work area.

1. When possible, move the work to a location well away from combustible materials. If relocation is not possible, protect the combustibles with a cover made of fire resistant material.
2. Remove or make safe all combustible materials for a radius of 10 metres around the work area. Use a fire resistant material to cover or block all doorways, windows, cracks, and other openings.
3. Enclose the work area with portable fire resistant screens. Protect combustible walls, ceilings, floors, etc., from sparks and heat with fire resistant covers.
4. If working on a metal wall, ceiling, etc., prevent ignition of combustibles on the other side by moving the combustibles to a safe location. If relocation of combustibles is not possible, designate someone to serve as a fire watch, equipped with a fire extinguisher, during the welding process and well after the welding is completed.
5. Do not weld or cut on materials having a combustible coating or combustible internal structure, as in walls or ceilings, without an approved method for eliminating the hazard.
6. After welding, make a thorough examination for evidence of fire. Be aware that visible smoke or flame may not be present for some time after the fire has started. Do not weld or cut in atmospheres containing dangerously reactive or flammable gases, vapours, liquids, and dust. Provide adequate ventilation in work areas to prevent accumulation of flammable gases, vapours, and dust.
7. Do not apply heat to a container that has held an unknown substance or a combustible material whose contents, when heated, can produce flammable or explosive vapours. Clean and purge containers before applying heat. Vent closed containers, including castings, before preheating, welding, or cutting.

14.4.5 Electricity Can Kill



DANGER! Touching live electrical parts can cause fatal shocks or severe burns.
The electrode and work circuit is electrically live whenever the output is on.

The input power circuit and machine internal circuits are also live when power is on. In semiautomatic or automatic wire welding, the wire, wire reel, drive roll housing, and all metal parts touching the welding wire are electrically live. Incorrectly installed or improperly grounded equipment is a hazard.

1. Do not touch live electrical parts.
2. Wear dry, hole-free insulating gloves and body protection.
3. Insulate yourself from the work and the ground using dry insulating mats or covers.
4. Disconnect input power before installing or servicing this equipment. Lock input power, disconnect switch open, or remove line fuses so power cannot be turned on accidentally.

5. Properly install and ground this equipment according to national, state, and local codes.
6. Turn off all equipment when not in use. Disconnect power to equipment if it will be left unattended or out of service.
7. Use fully insulated electrode holders. Never dip the holder in water to cool it or lay it down on the ground or the work surface. Do not touch holders connected to two welding machines at the same time or touch other people with the holder or electrode.
8. Do not use worn, damaged, undersized, or poorly spliced cables.
9. Do not wrap cables around your body.
10. Connect work piece to a good electrical ground.
11. Do not touch the electrode while in contact with the work (ground) circuit.
12. Use only well-maintained equipment. Repair or replace damaged parts as soon as practical.
13. In confined spaces or damp locations, do not use a welder with AC output unless equipped with a voltage reducer.

Arc rays from the welding process produce intense heat and strong ultraviolet rays that can burn eyes and skin. Use the following table to select the appropriate shade number for a Welding Helmet or Welding Face Shield.

Recommended Protection Filters For Electric Welding		
Welding Process / Application	Approximate Range of Welding Current in Amps	Minimum Shade Number of Filter Lens
Stick (MMA)	Up to 100	8
	100 to 200	10
MIG (other than Aluminum and Stainless Steel)	Up to 150	10
	150 to 250	11
MIG of Aluminum and Stainless Steel	Up to 250	12
MIG Flux-Cored Arc Welding (FCAW) – with or without Shielding Gas	Up to 300	10
TIG	Up to 100	10
	100 to 200	11

Table 16

14.4.6 Fumes And Gases



WARNING! Welding produces fumes and gases. Breathing these fumes and gases can be hazardous to your health.

1. Keep your head out of the fumes. Do not breathe the fumes.
2. If inside, ventilate the area and/or use an exhaust at the arc to remove welding fumes and gases.
3. If ventilation is poor, use an approved supplied-air respirator (PAPR).
4. Read the Safety Data Sheets (SDS) and the manufacturer's instruction for the metals, consumables, coatings, and cleaners.
5. Work in a confined space only if it is well ventilated, or while wearing an air-supplied respirator. Shielding gases used for welding can displace air causing injury or death. Be sure the breathing air is safe.

6. Do not weld in locations near degreasing, cleaning, or spraying operations. The heat and rays of the arc can react with vapours to form highly toxic and irritating gases.
7. Do not weld on coated metals, such as galvanized, lead, or cadmium plated steel, unless the coating is removed from the weld area, the area is well ventilated, and if necessary, while wearing an air- supplied respirator. The coatings and any metals containing these elements can give off toxic fumes if welded.

14.4.7 Fire & Explosive Risks



WARNING! Sparks and spatter fly off from the welding arc. The flying sparks and hot metal, weld spatter, work piece, and hot equipment can cause fires and burns.

Accidental contact of electrode or welding wire to metal objects can cause sparks, overheating, or fire.

1. Protect yourself and others from flying sparks and hot metal.
2. Do not weld where flying sparks can strike flammable material.
3. Remove all flammables within 10m of the welding site.
4. Be alert that welding sparks and hot materials from welding can easily go through small cracks and openings to adjacent areas.
5. Watch for fire, and keep a fire extinguisher nearby.
6. Be aware that welding on a ceiling, floor, bulkhead, or partition can cause fire on the hidden side.
7. Do not weld on closed containers such as tanks or drums.
8. Connect the work lead/clamp to the job as close to the welding area as practical to prevent welding current from traveling long, possibly unknown paths and causing electric shock and fire hazards.
9. Do not use a welder to thaw frozen pipes.
10. Remove the stick electrode from the holder or cut off the welding wire at the contact tip when not in use.

14.4.8 Sparks & Hot Metal



WARNING! Chipping and grinding causes flying metal, and as welds cool they can throw off slag.

1. Wear an AS/NZS approved face shield or safety goggles. Side shields are recommended.
2. Wear appropriate safety equipment to protect the skin and body.

14.4.9 Gas Cylinders



WARNING! *Gas cylinders contain gas under high pressure. If damaged, a cylinder can explode. Since gas cylinders are normally part of the welding process, be sure to treat them carefully.*

1. Protect compressed gas cylinders from excessive heat, mechanical shocks, and arcs.
2. Install and secure cylinders in an upright position by chaining them to a stationary support or equipment cylinder rack to prevent falling or tipping.
3. Keep cylinders away from any welding or other electrical circuits.
4. Never allow a welding electrode to touch any cylinder.
5. Use appropriate shielding gas, regulators, hoses, and fittings designed for the specific application; maintain them and their associated parts in good condition.
6. Turn your face away from the valve outlet when opening the cylinder valve.

Warranty

As part of an on-going commitment to excellence in product support, Euroquip offers a comprehensive product warranty program.

Registered warranty period for the MST140i:

Commercial Use: 18 Months

Domestic Use: 18 Months

Warranty covers failure caused by manufacturing and material defects in the product, during the warranty period specified. The warranty period begins when the product is purchased by the end user. Warranty is not transferrable and is only claimable by the original purchaser.

Warranty does not cover parts that are subject to wear and tear from usage.

Warranty covers failure of a product caused by defective materials and/or manufacturing for the period given and the usage specified by Euroquip. The warranty period begins when the product is purchased by the end user. Warranty is not transferrable and is only claimable by the original purchaser.

Warranty also does not cover failure caused by the untimely replacement or service of the above wearing parts. Evidence must be provided that the product has been maintained and serviced suitably for a claim to be considered under warranty.

Failure caused by incorrect operation of the product, lack of proper care and maintenance of the product, external damage, external circumstances such as contaminated fuel or poor water supply, modifications to the product, attempted repair/ service by a party other than an Approved Service Agent, is not covered under warranty.

Warranty does not cover pre delivery service and ad-

justment, or failure that may occur as a result of lack of/ incorrect pre delivery service and adjustment.

Warranty does not cover any incidental, indirect or consequential loss, damage or expense that may result from any defect, failure or malfunction of a product.

Should any issue be found to be a combination of a warranty failure and a non-warranty issue, the repair cost component to rectify and repair the non-warranty failure is the customers' full responsibility.

The decision that an issue with a product qualifies as a warranty claim is made at the sole jurisdiction of Euroquip.

No costs incurred will be considered under warranty if repairs are carried out by a party other than a Euroquip Approved Service Agent, unless with prior consent in writing from Euroquip.

It is the responsibility of the purchaser to deliver a product under warranty to the nearest relevant service agent or product reseller. Warranty does not cover call outs, mileage and freight costs.

If a product is repaired under warranty, parts and labour required for the repair will be supplied at no charge. Warranty assessment and repair will be scheduled and executed according to the normal work flow at the service location and depending on the availability of suitable replacement parts.

This warranty policy is an additional benefit and does not affect the legal rights of any end user, reseller or service agent.

Notes

Notes

Notes



Congratulations on your new WELDTECH product. We are proud to have you as our customer and will strive to provide you with the best service and reliability in the industry. This product is backed by our extensive warranty and service network. To locate your nearest distributor or service agency visit www.weldtech.net.nz, or email us at customerservice@euroquip.co.nz

www.weldtech.net.nz