



# EZIARC 160I/200I MMA INVERTER WELDER

## OPERATING INSTRUCTIONS



### 👉 IMPORTANT!

Read these Operating Instructions Completely before attempting to use this machine. Save this manual and keep it handy for quick reference. Pay particular attention to the safety instructions we have provided for your protection. Contact your distributor if you do not fully understand anything in this manual.





# EZIARC 160I/200I

## Contents

Know Your Machine.....	6
Quick Start Guide.....	7
Tips & Tricks.....	8
Care & Maintenance.....	9
MMA (Stick) Basic Welding Guide.....	9
Troubleshooting.....	15
Knowledge & Resources.....	16
Safety.....	16
Warranty.....	21



  
**160A**  
Max Output (ARC)

  
**4.0mm**  
Max Electrode Size

  
**15A**  
230V



## 160A DC ARC/Lift TIG Inverter Welder

- ✓ **Lightweight & Compact Design** - Ideal for portable applications
- ✓ **Production tested with 440V** - Extreme stress testing in production for rugged reliability.
- ✓ **Lift TIG Welding Operation** - Precision and aesthetically important welding jobs
- ✓ **Industrial IP23 casing with front panel protection** - Resistant to damage, moisture and corrosion
- ✓ **Intelligent Protection System** - Temperature, voltage and current sensors for increased reliability & safety
- ✓ **IGBT Inverter Technology** - Smooth & stable welding output, increased reliability
- ✓ **Microprocessor Control System** - Superior Arc Characteristics
- ✓ **Digital Current Display Meter** - Accurate pre setting and feedback of welding parameters & output.
- ✓ **High Quality & Over-Specified Electronic Components** - Durability & Reliability
- ✓ **Generator Friendly** - Designed to work with generator power supply and protect from power surges.

Description	Details
<b>DIMENSIONS (LxWxH)</b>	290 x 135 x 220mm
<b>WEIGHT</b>	2.8kg
<b>INPUT POWER SUPPLY</b>	230V AC 15A 50/60Hz
<b>INPUT POWER SUPPLY TOLERANCE</b>	+/- 10%
<b>MAXIMUM INPUT CURRENT</b>	36A
<b>GENERATOR CAPACITY</b>	8.5 KVA
<b>MMA CURRENT OUTPUT</b>	10A-160A
<b>MMA O/C VOLTAGE</b>	70V
<b>MMA DUTY CYCLE</b>	160A@15% 105A@60% 80A@100%
<b>LIFT TIG CURRENT OUTPUT</b>	10-160A
<b>LIFT TIG DUTY CYCLE</b>	160A@15% 105A@60% 80A@100%

Description	Details
<b>INSULATION CLASS</b>	IP23
<b>MMA ROD SIZE</b>	1.6 - 4.0mm
<b>POWER EFFICIENCY</b>	80%
<b>POWER FACTOR</b>	0.65
<b>STANDARDS</b>	AS/ IEC60974-1:2012
<b>WARRANTY</b>	48 Months

### Includes:



### Optional:



**EZIARC160i**  
User guide, specs, videos

LEARN MORE





# STRATA

SUPERIOR WELDING PRODUCTS

ARC TIG **200A**  
**EZIARC200i**



  
**200A**  
Max Output (ARC)

  
**4.0mm**  
Max Electrode Size

  
**15A**  
230V



## 200A DC ARC/Lift TIG Inverter Welder

- ✓ **Lightweight & Compact Design** - Ideal for portable applications
- ✓ **Intelligent Protection System** - Temperature, voltage and current sensors for increased reliability & safety
- ✓ **Production tested with 440V** - Extreme stress testing in production for rugged reliability.
- ✓ **Lift TIG Welding Operation** - Precision and aesthetically important welding jobs
- ✓ **Industrial IP23 casing with front panel protection** - Resistant to damage, moisture and corrosion
- ✓ **IGBT Inverter Technology** - Smooth & stable welding output, increased reliability
- ✓ **Microprocessor Control System** - Superior Arc Characteristics
- ✓ **Digital Current Display Meter** - Accurate pre setting and feedback of welding parameters & output.
- ✓ **High Quality & Over-Specified Electronic Components** - Durability & Reliability
- ✓ **Generator Friendly** - Designed to work with generator power supply and protect from power surges.
- ✓ Accessories included are 4m ARC Lead with Heavy Duty Twist Lock Electrode Holder and 4m Earth Lead with Heavy Duty Earth Clamp

Description	Details
<b>DIMENSIONS (LxWxH)</b>	290 x 135 x 220mm
<b>WEIGHT</b>	3.2kg
<b>INPUT POWER SUPPLY</b>	230V AC 15A 50/60Hz
<b>INPUT POWER SUPPLY TOLERANCE</b>	+/- 10%
<b>MAXIMUM INPUT CURRENT</b>	46A
<b>GENERATOR CAPACITY</b>	12KVA
<b>MMA CURRENT OUTPUT</b>	10 - 200A
<b>MMA O/C VOLTAGE</b>	70V
<b>MMA DUTY CYCLE</b>	200A@10% 130A@60% 100A@100%
<b>LIFT TIG CURRENT OUTPUT</b>	10A-200A
<b>LIFT TIG DUTY CYCLE</b>	200A@10% 130A@60% 100A@100%

Description	Details
<b>INSULATION CLASS</b>	IP23
<b>MMA ROD SIZE</b>	1.6 - 4.0mm
<b>POWER EFFICIENCY</b>	80%
<b>POWER FACTOR</b>	0.65
<b>STANDARDS</b>	AS/ IEC60974-1:2012
<b>WARRANTY</b>	48 Months

### Includes:



### Optional:



**EZIARC200i**  
User guide, specs, videos

LEARN MORE



## ARC WELDING ACCESSORIES & CONSUMABLES

○ Standard ● Optional

ACCESSORY:	EZIARC140i	EZIARC160i	EZIARC200i	ADVANCEARC160i	ADVANCEARC200i
Arc Leads	○ AAL1625	○ AAL1625	○ AAL1625	○ AAL3550	○ AAL3550
Earth Leads	○ AEL1625	○ AEL1625	○ AEL1625	○ AEL3550	○ AEL3550
TIG Torch	● TWP17V-12-2D	● TWP17V-12-2D	● TWP17V-12-2D	● TWP26V-12-2D	● TW26V-12-2D
Argon Regulator	● GR105AR	● GR102ARFL	● GR102ARFL	● GR102ARFL	● GR102ARFL
TIG Consumables Kit	● DCKIT	● DCKIT	● DCKIT	● DCKIT	● DCKIT

### Flip Front Welding Helmet

<b>WT150</b>	Flip Front Helmet (MIG/MMA)
--------------	-----------------------------



### Automatic Welding Helmets

- ✓ Variable Shade
- ✓ Complete with batteries ready to go
- ✓ Suitable for automotive DIY and industrial use.

<b>WT180</b>	Variable Shade 9-13
<b>WT350</b>	True Colour, 4 Sensor with grind function
<b>SV3000</b>	True Colour, Shade 5 - 13 + Grind Function (MIG/TIG/MMA/Plasma)
<b>SV4000</b>	Panoramic view with auto darkening side panels, Shade 4 - 13 + Grind Function (MIG/TIG/MMA/Plasma)
<b>DW7000XL</b>	True Colour, with grinding visor. Shade 5 - 13 + PRSL Filtration System (MIG/TIG/MMA/Plasma)



WT180



WT350



SV3000



SV4000



DW7000XL comes with battery powered air respirator.



WT-AWG01



WT-AWG02



WT-TWG20

### Premium Welding Gloves

- ✓ Fully lined
- ✓ Quality Hard-Wearing Leather
- ✓ One piece back
- ✓ Special "comfort fit".

<b>WT-AWG01</b>	Black/Gold Gloves - Pair
<b>WT-AWG02</b>	Red/Gold Gloves - Pair
<b>WT-TWG20</b>	TIG Welding Gloves - Pair

### Welding Magnets

<b>WT-WMG03</b>	3" Welding Magnet
<b>WT-WMG05</b>	5" Welding Magnet



### Chipping Hammer

- ✓ Heavy duty chipping hammer for the trade

<b>WT-SPCH</b>	Spring Handle Chipping Hammer
----------------	-------------------------------



### ARC Welding Electrodes - 1KG

<b>WEL1KG-16</b>	1.6mm E6013 GP Electrodes
<b>WEL1KG-20</b>	2.0mm E6013 GP Electrodes
<b>WEL1KG-25</b>	2.5mm E6013 GP Electrodes
<b>WEL1KG-32</b>	3.2mm E6013 GP Electrodes
<b>WEL316-25</b>	2.5mm 316L S/S Electrodes
<b>WEL316-32</b>	3.2mm 316L S/S Electrodes
<b>WEL312-25</b>	2.5mm 312 Weld-All Electrodes
<b>WEL312-32</b>	3.2mm 312 Weld-All Electrodes
<b>WELCi-25</b>	2.5mm Cast Iron NiFe Electrodes
<b>WELCi-32</b>	3.2mm Cast Iron NiFe Electrodes
<b>WEL7018-32</b>	3.2mm 7018 Low Hydrogen Electrodes
<b>WELHF-32</b>	3.2mm HF600 Hard Facing Electrodes





## Know Your Machine



1. MMA/ Stick Welding Mode Indicator
2. Lift TIG Welding Mode Indicator
3. Current Adjustment/ Mode Selector Knob
4. Negative (-) welding power output connection socket
5. Positive (+) welding power output connection socket
6. Welding current digital display meter
7. Start/ Power Indicator Light – Lights when mains power is connected and machine is switched on
8. Alarm/Over Temp Indicator Lamp - Lights when over voltage, current or temperature is detected and protection is activated. When activated, welding output will be disabled until the overload condition has reduced sufficiently and indicator lamp goes out. – Refer duty cycle rating. If this indicator light stays illuminated permanently, this may indicate internal machine damage, in which case please contact Strata customer service.



# EZIARC 160I/200I

## Quick Start Guide

Electrical Connection: The EziArc160/200i is designed to operate on a 15A 230V AC power supply.

If using an extension cord, it should be no longer than 15m and a heavy duty specification with minimum cable size of 2.5mm<sup>2</sup>. Recommended Strata extension cable item code: #16895

If powering from a generator, refer to specification table at the start of this manual for required generator capacity.

### Operating Environment

Adequate ventilation is required to provide proper cooling for the EziArc160/200i. Ensure that the machine is placed on a stable level surface where clean cool air can easily flow through the unit. The EziArc160i has electrical components and control circuit boards which may be damaged by excessive dust and dirt, so a clean operating environment is important.

## Basic Operation

### 1. MMA/ Stick Welding Operation

1.1 Connect the earth cable quick connector to the negative welding power output socket (4) Connect the earth clamp to the work piece. Contact with the work piece must be firm contact with clean, bare metal, with no corrosion, paint or scale at the contact point.

1.2 Insert an electrode into the electrode holder and connect the electrode holder and work lead to the positive welding power output socket (5).

Note: This polarity connection configuration is valid for most GP (General Purpose) MMA electrodes. There are variances to this. If in doubt, check the electrode specifications or consult the electrode manufacturer.

1.3 Connect the machine to suitable mains power using the mains input power lead. Switch the mains power switch to 'on' to power up the machine. Select MMA welding mode by pushing on the selector knob (3) until the MMA mode light (1) is illuminated.

1.4 Select the required output current by turning the current adjustment knob (3), the selected current will be displayed on the LCD screen (6). You are now ready to weld!

### 2. Lift TIG Operation

Note: Lift TIG operation requires an optional valve control TIG torch (item code: TWP17V-12-2D), TIG suitable argon regulator (item code: GR102ARFL) & argon gas cylinder.

2.1 Connect the earth cable quick connector to the positive welding power output socket (5). Connect the earth clamp to the work piece. Contact with the work piece must be firm contact with clean, bare metal, with no corrosion, paint or scale at the contact point.

2.2 Insert TIG torch power connection into the negative welding power output socket (4). Connect valve TIG torch gas line to the regulator, ensuring all connections are tight.

2.3 Open gas cylinder valve and adjust regulator, flow should be between 5-10 l/min depending on application. Re-check regulator flow pressure with torch valve open as static gas flow setting may drop once gas is flowing.

2.4 Connect the machine to suitable mains power using the mains input power lead. Switch the mains power switch to 'on' to power up the machine. Select MMA welding mode by pushing on the selector knob (3) until the TIG mode light (2) is illuminated.

2.5 Select the required output current by turning the current adjustment knob (3), the selected current will be displayed on the LCD screen (6). You are now ready to weld!



## EZIARC 160I/200I

### Tips & Tricks

#### Duty Cycle Rating

Welding duty cycle is the percentage of actual welding time that can occur in a ten minute cycle. E.g. 15% at 105 amps - this means the welder can operate at 105 amps for 1.5 minutes and then the unit will need to be rested for 8.5 minutes. All duty cycle ratings are based on an ambient air temperature of 40°C with 50% humidity, which is the international standard for such a rating. In an environment with temperatures exceeding 40°C, the duty cycle will be less than stated. In ambient temperature less than 40°C, duty cycle performance will be higher.





## Care & Maintenance

### Keep Your Welding Machine in Top Condition

The EziArc140i does not require any special maintenance, however the user should take care of the machine as follows:

- Regularly clean the ventilation slots.
- Keep the casing clean.
- Check all cables before use.
- Check electrode holders, work lead/clamps and welding torches before use.
- Replace worn electrode holders and earth clamps, which do not provide a good connection.
- Replace worn consumable parts in a timely manner.
- Use a soft cloth or brush to clean electrical components.
- Do not use liquid cleaning products, water or especially solvents.
- Do not use compressed air to clean electrical components as this can force dirt and dust further into components, causing electrical short circuits.
- Check for damaged parts. Do not use the welder with damaged parts.

If damaged, before further use, the welder must be carefully checked by a qualified person to determine that it will operate properly. Check for breakage of parts, mountings and other conditions that may affect its operation.

Have your welder repaired by an expert. An authorised service centre should properly repair a damaged part.

This appliance is manufactured in accordance with relevant safety standards. Only experts must carry out repairing of electrical appliances, otherwise considerable danger for the user may result. Use only genuine replacement parts. Do not use modified or non-genuine parts.

### Storing the Welder

When not in use the welder should be stored in the dry and frost-free environment.



**WARNING!** Before performing cleaning/maintenance, replacing cables / connections , make sure the welding machine is switched off and disconnected from the power supply.

## MMA (Stick) Basic Welding Guide

### Size of Electrodes

The electrode size is determined by the thickness of metals being joined and can also be governed by the type of welding machine available. Small welding machines will only provide current (amperage) to run smaller sized electrodes.

For thin sections, it is necessary to use smaller electrodes otherwise the arc may burn holes through the job. A little practice will soon establish the most suitable electrode for a given application.

### Storage of Electrodes

Always store electrodes in a dry place and in their original containers.

### Electrode Polarity

Electrodes are generally connected to the electrode holder with the electrode holder connected positive polarity.

The work lead is connected to the negative polarity and is connected to the work piece. If in doubt consult the electrode data sheet.

## Effects of MMA(Stick) Welding Various Materials

### High Tensile and Alloy Steels

The two most prominent effects of welding these steels are the formation of a hardened zone in the weld area, and, if suitable precautions are not taken, the occurrence in this zone of under-bead cracks. Hardened zone and underbead cracks in the weld area may be reduced by using the correct electrodes, preheating, using higher current settings, using larger electrodes sizes, short runs for larger electrode deposits or tempering in a furnace.

### Manganese Steels

The effect on manganese steel of slow cooling from high temperatures causes embrittlement. For this reason it is absolutely essential to keep manganese steel cool during welding by quenching after each weld or skip welding to distribute the heat.



# EZARC 160I/200I

## Cast Iron

Most types of cast iron, except white iron, are weldable. White iron, because of its extreme brittleness, generally cracks when attempts are made to weld it. Trouble may also be experienced when welding white-heart malleable, due to the porosity caused by gas held in this type of iron.

## Copper and Alloys

The most important factor is the high rate of heat conductivity of copper, making pre-heating of heavy sections necessary to give proper fusion of weld and base metal.

## Types of Electrodes

Arc Welding electrodes are classified into a number of groups depending on their applications. There are a great number of electrodes used for specialised industrial purposes which are not of particular interest for everyday general work. These include some low hydrogen types for high tensile steel, cellulose types for welding large diameter pipes, etc. The range of electrodes dealt with in this publication will cover the vast majority of applications likely to be encountered; are all easy to use.

### Electrodes for joining different metals:

#### MILD STEEL :

**E6011** - This electrode is used for all-position welding or for welding on rusty, dirty, less-than- new metal. It has a deep, penetrating arc and is often the first choice for repair or maintenance work.

**E6013** - This all-position electrode is used for welding clean, new sheet metal. Its soft arc has minimal spatter, moderate penetration and an easy-to-clean slag.

**E7014** - All positional, ease to use electrode for use on thicker steel than E6013. Especially suitable for sheet metal lap joints, fillet welds and general purpose plate welding.

**E7018** - A low-hydrogen, all-position electrode used when quality is an issue or for hard-to-weld metals. It has the capability of producing more uniform weld metal, which has better impact properties at low temperatures.

#### CAST IRON:

**ENI-CL** - Suitable for joining all cast irons except white cast iron.

#### STAINLESS STEEL:

**E318L-16** - High corrosion resistances. Ideal for dairy work etc.

**Flat Position,  
Down Hand Butt Weld  
(Fig 1-11)**

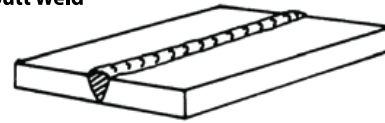

**Flat Position,  
Gravity Fillet Weld  
(Fig 1-12)**

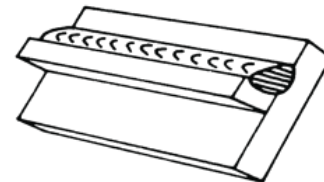

**Horizontal Position,  
Butt Weld  
(Fig 1-13)**

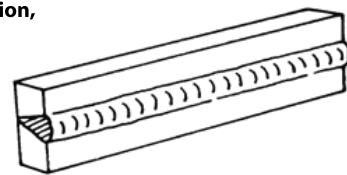

**Horizontal-Vertical  
(HV) Position  
(Fig 1-14)**

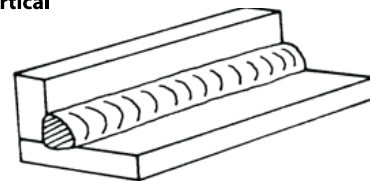

**Vertical Position,  
Butt Weld  
(Fig 1-15)**

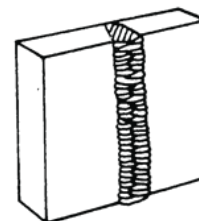

**Vertical Position,  
Fillet Weld  
(Fig 1-16)**

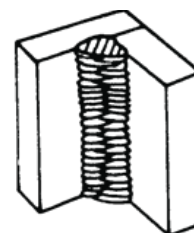

**Overhead Position,  
Butt Weld  
(Fig 1-17)**



**Overhead Position,  
Fillet Weld  
(Fig 1-18)**

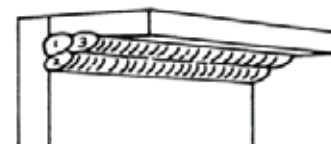

## Joint Preparations

In many cases, it will be possible to weld steel sections without any special preparation. For heavier sections and for repair work on castings, etc., it will be necessary to cut or grind an angle between the pieces being joined to ensure proper penetration of the weld metal and to produce sound joints.

In general, surfaces being welded should be clean and free of rust, scale, dirt, grease, etc. Slag should be removed from oxy-cut surfaces. Typical joint designs are shown in Figure 1-19.

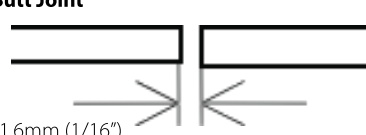
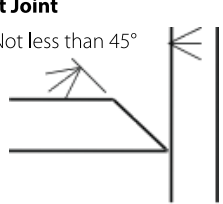
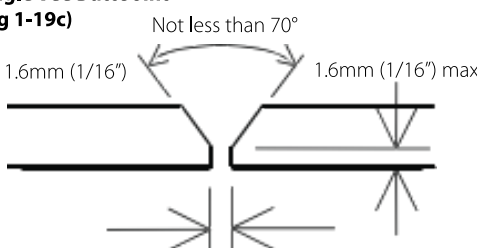
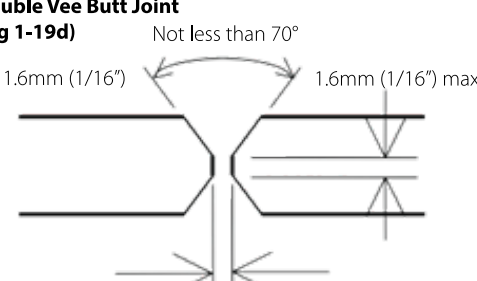
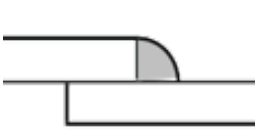
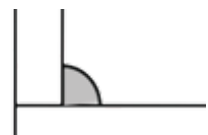
<p><b>Open Square Butt Joint (Fig 1-19a)</b></p>  <p>Gap varies from 1.6mm (1/16") to 4.8mm (3/16") depending on plate thickness</p>
<p><b>Single Vee Butt Joint (Fig 1-19b)</b></p> <p>Not less than 45°</p> 
<p><b>Single Vee Butt Joint (Fig 1-19c)</b></p> <p>Not less than 70°</p> <p>1.6mm (1/16")</p> <p>1.6mm (1/16") max.</p> 
<p><b>Double Vee Butt Joint (Fig 1-19d)</b></p> <p>Not less than 70°</p> <p>1.6mm (1/16")</p> <p>1.6mm (1/16") max.</p> 
<p><b>Lap Joint (Fig 1-19e)</b></p> 
<p><b>Fillet Joint (Fig 1-19f)</b></p> 

**Corner Weld (Fig 1-19g)**

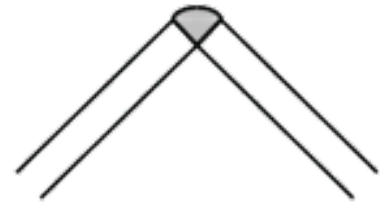

**Tee Joints (Fig 1-19h)**

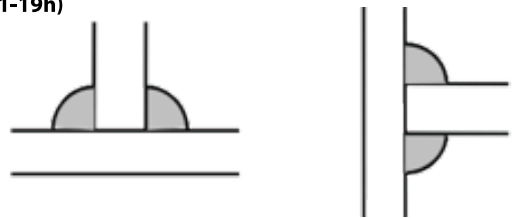

**Edge Joint (Fig 1-19i)**

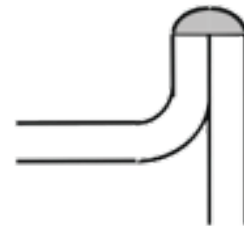

**Plug Welds (Fig 1-19j)**





## Arc Welding Techniques - A Word for Beginners

For those who have not yet done any welding, the simplest way to commence is to run beads on a piece of scrap plate. Use mild steel plate about 6.0mm thick and a 3.2mm electrode.

Clean any paint, loose scale or grease off the plate and set it firmly on the work bench so that welding can be carried out in the down hand position. Make sure that the Work Lead/Clamp is making good electrical contact with the work, either directly or through the work table. For light gauge material, always clamp the work lead directly to the job, otherwise a poor circuit will probably result.

### The Welder

Place yourself in a comfortable position before beginning to weld. Get a seat of suitable height and do as much work as possible sitting down. Don't hold your body tense. A taut attitude of mind and a tensed body will soon make you feel tired. Relax and you will find that the job becomes much easier. You can add much to your peace of mind by wearing a leather apron and gauntlets. You won't be worrying then about being burnt or sparks setting alight to your clothes.

Place the work so that the direction of welding is across, rather than to or from, your body. The electrode holder lead should be clear of any obstruction so that you can move your arm freely along as the electrode burns down. If the lead is slung over your shoulder, it allows greater freedom of movement and takes a lot of weight off your hand. Be sure the insulation on your cable and electrode holder is not faulty; otherwise you are risking an electric shock.

### Striking the Arc

Practice this on a piece of scrap plate before going on to more exacting work. You may at first experience difficulty due to the tip of the electrode "sticking" to the work piece. This is caused by making too heavy a contact with the work and failing to withdraw the electrode quickly enough. A low amperage will accentuate it. This freezing-on of the tip may be overcome by scratching the electrode along the plate surface in the same way as a match is struck. As soon as the arc is established, maintain a 1.6mm to 3.2mm gap between the burning electrode end and

the parent metal. Draw the electrode slowly along as it melts down.

Another difficulty you may meet is the tendency, after the arc is struck, to withdraw the electrode so far that the arc is broken again. A little practice will soon remedy both of these faults.

Striking an Arc  
(Fig 1-20)

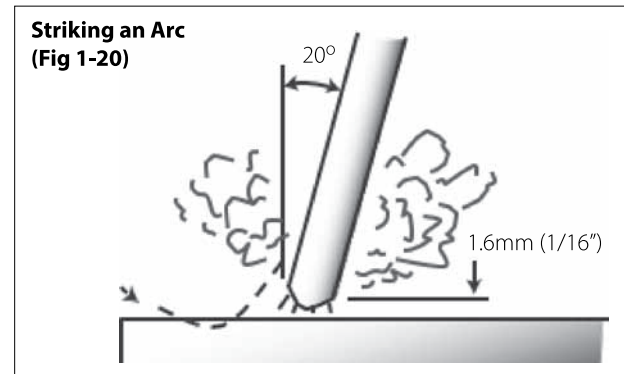

### Arc Length

The securing of an arc length necessary to produce a neat weld soon becomes almost automatic. You will find that a long arc produces more heat.

A very long arc produces a crackling or spluttering noise and the weld metal comes across in large, irregular blobs. The weld bead is flattened and spatter increases. A short arc is essential if a high quality weld is to be obtained although if it is too short there is the danger of it being blanketed by slag and the electrode tip being solidified in. If this should happen, give the electrode a quick twist back over the weld to detach it. Contact or "touch-weld" electrodes such as E7014 Stick electrodes do not stick in this way, and make welding much easier.

### Rate of Travel

After the arc is struck, your next concern is to maintain it, and this requires moving the electrode tip towards the molten pool at the same rate as it is melting away. At the same time, the electrode has to move along the plate to form a bead.

The electrode is directed at the weld pool at about 20° from the vertical. The rate of travel has to be adjusted so that a well-formed bead is produced.

If the travel is too fast, the bead will be narrow and strung out and may even be broken up into individual globules. If the travel is too slow, the weld metal piles up and the bead will be too large.



## Making Welded Joints

Having attained some skill in the handling of an electrode, you will be ready to go on to make up welded joints.

### A. Butt Welds

Set up two plates with their edges parallel, as shown in Figure 1-21, allowing 1.6mm to 2.4mm gap between them and tack weld at both ends. This is to prevent contraction stresses from the cooling weld metal pulling the plates out of alignment.

Plates thicker than 6.0mm should have their mating edges bevelled to form a 70° to 90° included angle. This allows full penetration of the weld metal to the root. Using a 3.2mm E7014 Stick electrode at 100 amps, deposit a run of weld metal on the bottom of the joint.

Do not weave the electrode, but maintain a steady rate of travel along the joint sufficient to produce a well-formed bead. At first you may notice a tendency for undercut to form, but keeping the arc length short, the angle of the electrode at about 20° from vertical, and the rate of travel not too fast, will help eliminate this.

The electrode needs to be moved along fast enough to prevent the slag pool from getting ahead of the arc. To complete the joint in thin plate, turn the job over, clean the slag out of the back and deposit a similar weld.

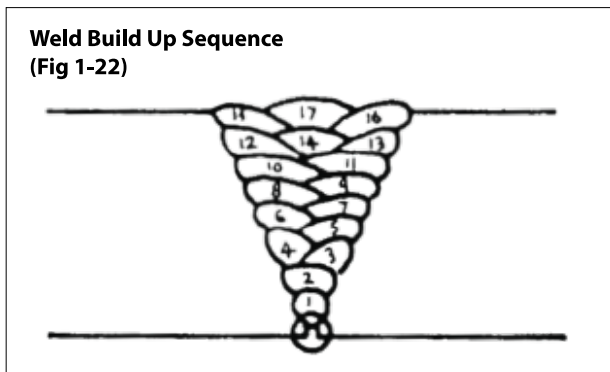
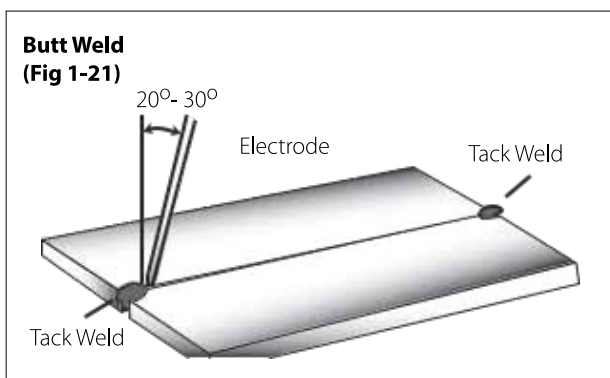

Heavy plate will require several runs to complete the joint. After completing the first run, chip the slag out and clean the weld with a wire brush. It is important to do this to prevent slag being trapped by the second run. Subsequent runs are then deposited using either a weave technique or single beads laid down in the sequence shown in Figure 1-22. The width of weave should not be more than three times the core wire diameter of the electrode.

When the joint is completely filled, the back is either machined, ground or gouged out to remove slag which may be trapped in the root, and to prepare a suitable joint for depositing the backing run. If a backing bar is used, it is not usually necessary to remove this, since it serves a similar purpose to the backing run in securing proper fusion at the root of the weld.

### B. Fillet Welds

These are welds of approximately triangular cross-section made by depositing metal in the corner of two faces meeting at right angles. Refer to Figure 1-14, 1-23 and 1-24.

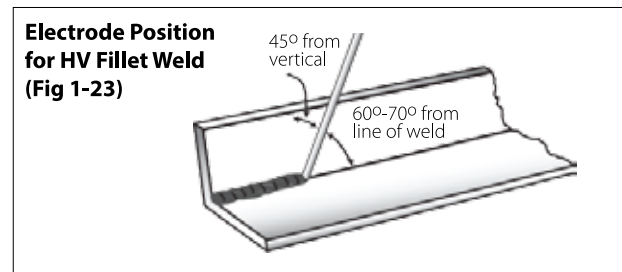

A piece of angle iron is a suitable specimen with which to begin, or two lengths of strip steel may be tacked together at right angles. Using a 3.2mm E7014 Stick electrode at 100 amps, position angle iron with one leg horizontal and the other vertical. This is known as a horizontal-vertical (HV) fillet.

Strike the arc and immediately bring the electrode to a position perpendicular to the line of the fillet and about 45° from the vertical. Some electrodes require being sloped about 20° away from the perpendicular position to prevent slag from running ahead of the weld. Refer to Figure 1-23.

Do not attempt to build up much larger than 6.4mm width with a 3.2mm electrode, otherwise the weld metal tends to sag towards the base, and undercut forms on the vertical leg. Multi-runs can be made as shown in Figure 1-24. Weaving in HV fillet welds is undesirable.



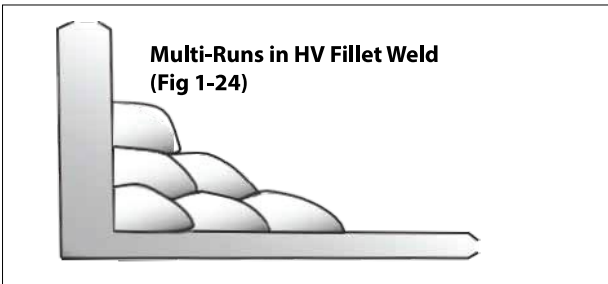

**Multi-Runs in HV Fillet Weld (Fig 1-24)**

## C. Vertical Welds

### 1. Vertical Up

Tack weld a three feet length of angle iron to your work bench in an upright position. Use a 3.2mm E7014 Stick electrode and set the current at 100 amps. Make yourself comfortable on a seat in front of the job and strike the arc in the corner of the fillet. The electrode needs to be about 10° from the horizontal to enable a good bead to be deposited. Refer Fig. 1-25.

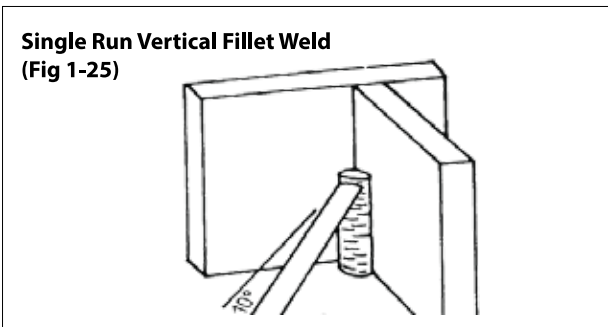

**Single Run Vertical Fillet Weld (Fig 1-25)**

Use a short arc, and do not attempt to weave on the first run. When the first run has been completed de-slag the weld deposit and begin the second run at the bottom. This time a slight weaving motion is necessary to cover the first run and obtain good fusion at the edges.

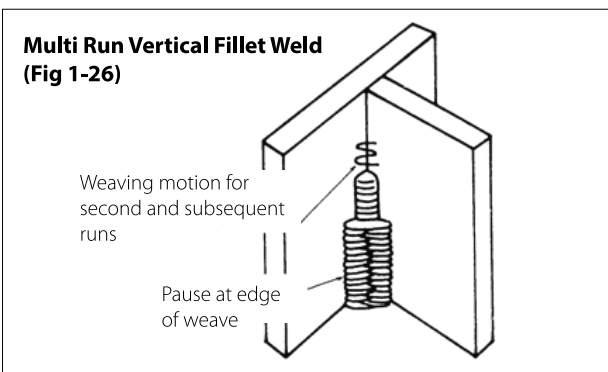

**Multi Run Vertical Fillet Weld (Fig 1-26)**

At the completion of each side motion, pause for a moment to allow weld metal to build up at the edges, otherwise undercut will form and too much metal will accumulate in the centre of the weld. Figure 1-26 illustrates multi-run technique and Figure 1-27 shows the effects of pausing at the edge of weave and of weaving too rapidly.

### Examples of Vertical Fillet Welds (Fig 1-27)

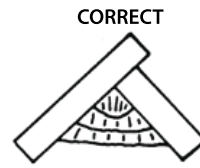

**CORRECT**  
Pause at edge of weave allows weld metal to build up and eliminates undercut

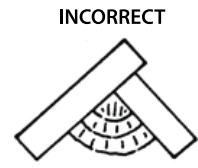

**INCORRECT**  
Note: Weld contour when insufficient pause at edge of weave

### 2. Vertical Down

The E7014 Stick electrode makes welding in this position particularly easy. Use a 3.2mm electrode at 100 amps. The tip of the electrode is held in light contact with the work and the speed of downward travel is regulated so that the tip of the electrode just keeps ahead of the slag. The electrode should point upwards at an angle of about 45°.

### 3. Overhead Welds

Apart from the rather awkward position necessary, overhead welding is not much more difficult than down hand welding.

Set up a specimen for overhead welding by first tacking a length of angle iron at right angles to another piece of angle iron or a length of waste pipe. Then tack this to the work bench or hold in a vice so that the specimen is positioned in the overhead position as shown in the sketch.

The electrode is held at 45° to the horizontal and tilted 10° in the line of travel (Figure 1-28). The tip of the electrode may be touched lightly on the metal, which helps to give a steady run. A weave technique is not advisable for overhead fillet welds.

Use a 3.2mm E6013 Stick electrode at 100 amps, and deposit the first run by simply drawing the electrode along at a steady rate. You will notice that the weld deposit is rather convex, due to the effect of gravity before the metal freezes.

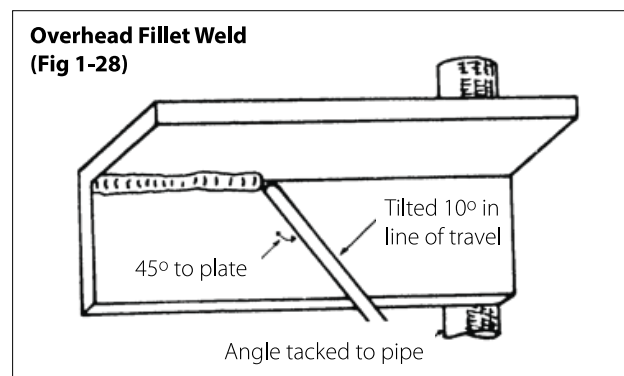

**Overhead Fillet Weld (Fig 1-28)**



# EZIARC 160I/200I

## Troubleshooting

Fault	Cause	Remedy
A gap is left by failure of the weld metal to fill the root of the weld.	Welding current too low.	Increase welding current.
	Electrode too large for joint.	Use smaller diameter electrode.
	Insufficient gap.	Allow wider gap.
Non-metallic particles are trapped in the weld metal.	Non-metallic particles may be trapped in undercut from previous run.	If a bad undercut is present clean slag out and cover with a run from a smaller gauge electrode.
	Joint preparation too restricted.	Allow for adequate penetration and room for cleaning out the slag.
	Irregular deposits allow slag to be trapped.	If very bad, chip or grind out irregularities.
	Lack of penetration with slag trapped beneath weld bead.	Use smaller electrode with sufficient current to give adequate penetration. Use suitable tools to remove all slag from comers.
	Rust or mill scale is preventing full fusion.	Clean joint before welding.
	Wrong electrode for position in which welding is done.	Use electrodes designed for position in which welding is done, otherwise proper control of slag is difficult.
<b>Figure 1: Example of insufficient gap or incorrect sequence</b> <p>Incorrect Sequence</p> <p>Insufficient Gap</p>		
A groove has been formed in the base metal adjacent to the toe of a weld and has not been filled by the weld metal (undercut).	Welding current is too high.	Reduce welding current.
	Welding arc is too long.	Reduce the length of the welding arc.
	Angle of the electrode is incorrect.	Electrode should not be inclined less than 45° to the vertical face.
	Joint preparation does not allow correct electrode angle.	Allow more room in joint for manipulation of the electrode.
	Electrode too large for joint.	Use smaller gauge electrode.
	Insufficient deposit time at edge of weave.	Pause for a moment at edge of weave to allow weld metal build-up.
	Power source is set for MIG (GMAW) welding.	Set power source to STICK (MMA) mode.
Portions of the weld run do not fuse to the surface of the metal or edge of the joint.	Small electrodes used on heavy cold plate.	Use larger electrodes and preheat the plate.
	Welding current is too low.	Increase welding current.
	Wrong electrode angle.	Adjust angle so the welding arc is directed more into the base metal.
	Travel speed of electrode is too high.	Reduce travel speed of electrode.
	Scale or dirt on joint surface.	Clean surface before welding.
<b>Figure 2: Example of Lack of Fusion</b> <p>Lack of fusion caused by dirt; electrode angle incorrect; rate of travel too high</p> <p>Lack of side fusion, scale dirt; small electrode; amperage too low</p> <p>Lack of inter-run fusion</p> <p>Lack of root fusion</p>		
Gas pockets or voids in weld metal (porosity)	High levels of sulphur in steel.	Use an electrode that is designed for high sulphur steels.
	Electrodes are damp.	Dry electrodes before use.
	Welding current is too high.	Reduce welding current.
	Surface impurities such as oil, grease, paint, etc.	Clean joint before welding.
	Welding in a windy environment.	Shield the weld area from the wind.
	Electrode damaged i.e. flux coating incomplete.	Discard damaged electrodes and only use electrodes with a complete flux coating.
Crack occurring in weld metal soon after solidification commences	Rigidity of joint.	Redesign to relieve weld joint of severe stresses or use crack resistance electrodes.
	Insufficient throat thickness.	Travel slightly slower to allow greater build up in throat.
	Weld current is too high.	Decrease welding current.
<b>Figure 3: Example of Slag Inclusion</b> <p>Not cleaned, or incorrect electrode</p> <p>Slag trapped in undercut</p> <p>Slag trapped in root</p>		



## Knowledge & Resources

Please refer to Euroquip website  
[www.euroquip.co.nz/Downloads.html](http://www.euroquip.co.nz/Downloads.html)  
for knowledgebase articles & operation videos.

## Safety

### Store and Retain this Manual

Retain this manual for the safety warnings and precautions, assembly, operating, inspection, maintenance and cleaning procedures. Write the product's serial number into the NOTES section at the rear, and keep this manual and the receipt in a safe and dry place for future reference.

### Important Safety Information

Failure to follow the warnings and instructions may result in electric shock, fire, serious injury and/or death. Save all warnings and instructions for future reference.



This is the safety alert symbol to alert you to potential personal injury hazards. Obey all safety messages that follow this symbol to avoid possible injury or death.



**DANGER!** indicates a hazardous situation which, if not avoided, will result in death or serious injury.



**WARNING!** indicates a hazardous situation which, if not avoided, could result in death or serious injury.



**CAUTION,** used with the safety alert symbol, indicates a hazardous situation which, if not avoided, could result in minor or moderate injury.

**NOTE,** used to address practices not related to personal injury.

**CAUTION,** without the safety alert symbol, is used to address practices not related to personal injury.

## GENERAL SAFETY WARNINGS

**1. Maintain labels and nameplates on the welder.** These carry important information. If unreadable or missing, contact Euroquip for a replacement.

**2. Avoid unintentional starting.** Make sure the welder is setup correctly and you are prepared to begin work before turning on the welder.

**3. Unplug before performing maintenance.**

Always unplug the welder from its electrical outlet before performing any inspection, maintenance, or cleaning procedures.

**4. Never leave the welder unattended while energised.** Turn power off before leaving the welder unattended.

**5. Do not touch live electrical parts.** Wear dry, insulating gloves. Do not touch the electrode or the conductor tong with bare hands. Do not wear wet or damaged gloves.

**6. Protect yourself from electric shock.** Do not use the welder outdoors. Insulate yourself from the work piece and the ground. Use non-flammable, dry insulating material if possible, or use dry rubber mats, dry wood or plywood, or other dry insulating material large enough to cover the area of contact with the work or the ground.

**7. Avoid inhaling dust.** Some dust created by power sanding, sawing, grinding, drilling, cutting, welding and other construction activities, contain chemicals known to cause cancer, birth defects or other harm. Your risk from these exposures varies, depending on how often you do this type of work. To reduce your exposure to these chemicals, work in a well-ventilated area, and work with approved safety equipment, such as dust masks that are specially designed to filter out microscopic particles.

**8. People with pacemakers should consult their physician(s) before using this machine.**



### WARNING!

Electromagnetic fields in close proximity to a heart pacemaker could cause interference, or failure of the pacemaker. The use of a Welder is **NOT RECOMMENDED** for pacemaker wearers. Consult your doctor.

**9. Ensure that the unit is placed on a stable location before use.**



### WARNING!

If this unit falls while plugged in, severe injury, electric shock, or fire may result.



## EZIARC 160I/200I

**10. Transportation Methods** Lift unit with the handles provided, or use a handcart or similar device of adequate capacity. If using a fork lift vehicle, secure the unit to a skid before transporting.



**CAUTION!**

*Disconnect input power conductors from de-energized supply line before moving the welding power source.*

**11. Exercise good work practices.** The warnings, precautions, and instructions discussed in this instruction manual cannot cover all possible conditions and situations that may occur. It must be understood by the operator that common sense and caution are factors which cannot be built into this product, but must be considered by the operator.

### Welding Safety Instructions & Warnings



**WARNING!**

*Protect yourself and others from possible serious injury or death. Keep children away. Read the operating/Instruction manual before installing, operating or servicing this equipment. Have all installation, operation, maintenance, and repair work performed by qualified people.*

If an operator does not strictly observe all safety rules and take precautionary actions, welding products and welding processes can cause serious injury or death, or damage to other equipment or property. Safe practices have developed from past experience in the use of welding and cutting.

These practices must be learned through study and training before using this equipment. Some of these practices apply to equipment connected to power lines; other practices apply to engine driven equipment. Anyone not having extensive training in welding and cutting practices should not attempt to weld.

Safe practices are outlined in the European Standard EN60974-1 entitled: Safety in welding and allied processes.



**WARNING!**

*Only use safety equipment that has been approved by an appropriate standards agency. Unapproved safety equipment may not provide adequate protection. Eye and breathing protection must be AS/NZS compliant for the specific hazards in the work area.*



**DANGER!**

*Always wear AS/NZS compliant safety glasses and full face shield fitted with appropriate filter shade number. (Refer Filter Table on page 17.)*



**CAUTION!**

*Heavy-duty work gloves, non-skid safety shoes and hearing protection used for appropriate conditions will reduce personal injuries.*



**CAUTION!**

*Have the equipment serviced by a qualified repair person using identical replacement parts. This will ensure that the safety of the power tool is maintained.*

### Personal Safety



**CAUTION!**

*Keep the work area well lit. Make sure there is adequate space surrounding the work area. Always keep the work area free of obstructions, grease, oil, trash, and other debris. Do not use equipment in areas near flammable chemicals, dust, and vapours. Do not use this product in a damp or wet location.*

1. Stay alert, watch what you are doing and use common sense when operating equipment. Do not use a tool while you are tired or under the influence of drugs, alcohol or medication. A moment of distraction when operating equipment may result in serious personal injury.
2. Do not overreach. Keep proper footing and balance at all times. This enables better control of the power tool in unexpected situations.

### Arc Rays can Burn Eyes and Skin



**DANGER!**

*Arc rays from the welding process produce intense heat and strong ultraviolet rays that can burn eyes and skin.*

1. Use a Welding Helmet or Welding Face Shield fitted with a proper shade filter (refer AS 60974-1, AS/NZS 1337.1 and AS/NZS 1338.1 Safety Standards) to protect your face and eyes when welding or watching. (See Filter Table on Page 17).
2. Wear approved safety glasses. Side shields are recommended.





## EZIARC 160I/200I

3. Use protective screens or barriers to protect others from flash and glare; warn others not to watch the arc.
4. Wear protective clothing made from durable, flame-resistant material (wool and leather) and foot safety protection.
5. Never wear contact lenses while welding.

### Noise Can Damage Hearing



#### CAUTION!

Noise from some processes can damage hearing. Use AS/NZS compliant ear plugs or ear muffs if the noise level is high.

### Work Environment Safety



#### DANGER!

Remove any combustible material from the work area.

1. When possible, move the work to a location well away from combustible materials. If relocation is not possible, protect the combustibles with a cover made of fire resistant material.
2. Remove or make safe all combustible materials for a radius of 10 metres around the work area. Use a fire resistant material to cover or block all doorways, windows, cracks, and other openings.
3. Enclose the work area with portable fire resistant screens. Protect combustible walls, ceilings, floors, etc., from sparks and heat with fire resistant covers.
4. If working on a metal wall, ceiling, etc., prevent ignition of combustibles on the other side by moving the combustibles to a safe location. If relocation of combustibles is not possible, designate someone to serve as a fire watch, equipped with a fire extinguisher, during the welding process and well after the welding is completed.
5. Do not weld or cut on materials having a combustible coating or combustible internal structure, as in walls or ceilings, without an approved method for eliminating the hazard.
6. After welding, make a thorough examination for evidence of fire. Be aware that visible smoke or flame may not be present for some time after the fire has started. Do not weld or cut in atmospheres containing dangerously reactive or flammable gases, vapours, liquids, and dust. Provide adequate ventilation in work areas to prevent accumulation of flammable gases, vapours, and dust.

7. Do not apply heat to a container that has held an unknown substance or a combustible material whose contents, when heated, can produce flammable or explosive vapours. Clean and purge containers before applying heat. Vent closed containers, including castings, before pre-heating, welding, or cutting.

### Electricity Can Kill



#### DANGER!

Touching live electrical parts can cause fatal shocks or severe burns. The electrode and work circuit is electrically live whenever the output is on.

The input power circuit and machine internal circuits are also live when power is on. In semi-automatic or automatic wire welding, the wire, wire reel, drive roll housing, and all metal parts touching the welding wire are electrically live. Incorrectly installed or improperly grounded equipment is a hazard.

1. Do not touch live electrical parts.
2. Wear dry, hole-free insulating gloves and body protection.
3. Insulate yourself from the work and the ground using dry insulating mats or covers.
4. Disconnect input power before installing or servicing this equipment. Lock input power, disconnect switch open, or remove line fuses so power cannot be turned on accidentally.
5. Properly install and ground this equipment according to national, state, and local codes.
6. Turn off all equipment when not in use. Disconnect power to equipment if it will be left unattended or out of service.
7. Use fully insulated electrode holders. Never dip the holder in water to cool it or lay it down on the ground or the work surface. Do not touch holders connected to two welding machines at the same time or touch other people with the holder or electrode.
8. Do not use worn, damaged, undersized, or poorly spliced cables.
9. Do not wrap cables around your body.
10. Connect work piece to a good electrical ground.





# EZIARC 160I/200I

11. Do not touch the electrode while in contact with the work (ground) circuit.
12. Use only well-maintained equipment. Repair or replace damaged parts as soon as practical.
13. In confined spaces or damp locations, do not use a welder with AC output unless equipped with a voltage reducer.

Arc rays from the welding process produce intense heat and strong ultraviolet rays that can burn eyes and skin. Use the following table to select the appropriate shade number for a Welding Helmet or Welding Face Shield.

1. Use a Welding Helmet or Welding Face Shield fitted with a proper shade of filter (see AS 60974-1, AS/NZS 1337.1 and AS/NZS 1338.1 Safety Standards) to protect your face and eyes when welding or watching.
2. Wear approved safety glasses. Side shields are recommended.
3. Use protective screens or barriers to protect others from flash and glare; warn others not to watch the arc.
4. Wear protective clothing made from durable, flame-resistant material (wool and leather) and foot protection.
5. Never wear contact lenses while welding.

Recommended Protective Filters for Electric Welding		
Description of Process	Approximate Range of Welding Current in Amps	Minimum Shade Number of Filter(s)
Manual Metal Arc Welding - Covered Electrodes (MMA)	Less than or equal to 100	8
	100 to 200	10
	200 to 300	11
	300 to 400	12
	Greater than 400	13
Gas Metal Arc Welding (GMAW) (MIG) other than Aluminium And Stainless Steel	Less than or equal to 150	10
	150 to 250	11
	250 to 300	12
	300 to 400	13
	Greater than 400	14
Gas Metal Arc Welding(GMAW) (MIG) Aluminium and Stainless Steel	Less than or equal to 250	12
	250 to 350	13
Gas Tungsten Arc Welding (GTAW) (TIG)	Less than or equal to 100	10
	100 to 200	11
	200 to 250	12
	250 to 350	13
	Greater than 350	14
Flux-Cored Arc Welding (FCAW) - with or without Shielding Gas	Less than or equal to 300	11
	300 to 400	12
	400 to 500	13
	Greater than 500	14
Air - Arc Gouging	Less than or equal to 400	12
Plasma - Arc Cutting	50 to 100	10
	100 to 400	12
	400 to 800	14
Plasma - Arc Spraying	—	15
Plasma - Arc Welding	Less than or equal to 20	8
	20 to 100	10
	100 to 400	12
	400 to 800	14
Submerged - Arc Welding	—	2 (5)
Resistance Welding	—	Safety Spectacles or Eye Shield

Refer to standard AS/NZS 1338.1 for comprehensive information regarding the above table.



## EZIARC 160I/200I

### Fumes And Gases



#### WARNING!

*Welding produces fumes and gases. Breathing these fumes and gases can be hazardous to your health.*

1. Keep your head out of the fumes. Do not breathe the fumes.
2. If inside, ventilate the area and/or use an exhaust at the arc to remove welding fumes and gases.
3. If ventilation is poor, use an approved air-supplied respirator.
4. Read the Safety Data Sheets (SDS) and the manufacturer's instruction for the metals, consumables, coatings, and cleaners.
5. Work in a confined space only if it is well ventilated, or while wearing an air-supplied respirator. Shielding gases used for welding can displace air causing injury or death. Be sure the breathing air is safe.
6. Do not weld in locations near degreasing, cleaning, or spraying operations. The heat and rays of the arc can react with vapours to form highly toxic and irritating gases.
7. Do not weld on coated metals, such as galvanized, lead, or cadmium plated steel, unless the coating is removed from the weld area, the area is well ventilated, and if necessary, while wearing an air-supplied respirator. The coatings and any metals containing these elements can give off toxic fumes if welded.

### Fire & Explosive Risks



#### WARNING!

*Sparks and spatter fly off from the welding arc. The flying sparks and hot metal, weld spatter, work piece, and hot equipment can cause fires and burns.*

Accidental contact of electrode or welding wire to metal objects can cause sparks, overheating, or fire.

1. Protect yourself and others from flying sparks and hot metal.
2. Do not weld where flying sparks can strike flammable material.
3. Remove all flammables within 10m of the welding site.
4. Be alert that welding sparks and hot materials from welding can easily go through small cracks and openings to adjacent areas.

5. Watch for fire, and keep a fire extinguisher nearby.
6. Be aware that welding on a ceiling, floor, bulkhead, or partition can cause fire on the hidden side.
7. Do not weld on closed containers such as tanks or drums.
8. Connect the work lead/clamp to the job as close to the welding area as practical to prevent welding current from travelling long, possibly unknown paths and causing electric shock and fire hazards.
9. Do not use a welder to thaw frozen pipes.
10. Remove the stick electrode from the holder or cut off the welding wire at the contact tip when not in use.

### Sparks & Hot Metal



#### WARNING!

*Chipping and grinding causes flying metal, and as welds cool they can throw off slag.*

1. Wear an AS/NZS approved face shield or safety goggles. Side shields are recommended.
2. Wear appropriate safety equipment to protect the skin and body.

### Cylinders



#### WARNING!

*Gas cylinders contain gas under high pressure. If damaged, a cylinder can explode. Since gas cylinders are normally part of the welding process, be sure to treat them carefully.*

1. Protect compressed gas cylinders from excessive heat, mechanical shocks, and arcs.
2. Install and secure cylinders in an upright position by chaining them to a stationary support or equipment cylinder rack to prevent falling or tipping.
3. Keep cylinders away from any welding or other electrical circuits.
4. Never allow a welding electrode to touch any cylinder.
5. Use appropriate shielding gas, regulators, hoses, and fittings designed for the specific application; maintain them and their associated parts in good condition.
6. Turn your face away from the valve outlet when opening the cylinder valve.



## EZIARC 160I/200I

### Warranty

As part of an on-going commitment to excellence in product support, Euroquip offers a comprehensive product warranty program.

#### **Warranty period for the EZIARC 160i/200i:**

**Commercial Use: 48 Months**

**Domestic Use: 48 Months**

Warranty covers failure caused by manufacturing and material defects in the product, during the warranty period specified. The warranty period begins when the product is purchased by the end user. Warranty is not transferrable and is only claimable by the original purchaser.

Warranty does not cover parts that are subject to wear and tear from usage.

Warranty covers failure of a product caused by defective materials and/or manufacturing for the period given and the usage specified by Euroquip. The warranty period begins when the product is purchased by the end user. Warranty is not transferrable and is only claimable by the original purchaser.

Warranty also does not cover failure caused by the untimely replacement or service of the above wearing parts. Evidence must be provided that the product has been maintained and serviced suitably for a claim to be considered under warranty.

Failure caused by incorrect operation of the product, lack of proper care and maintenance of the product, external damage, external circumstances such as contaminated fuel or poor water supply, modifications to the product, attempted repair/ service by a party other than an Approved Service Agent, is not covered under warranty.

Warranty does not cover pre delivery service and adjustment, or failure that may occur as a result of lack of/ incorrect pre delivery service and adjustment.

Warranty does not cover any incidental, indirect or consequential loss, damage or expense that may result from any defect, failure or malfunction of a product.

Should any issue be found to be a combination of a warranty failure and a non-warranty issue, the repair cost component to rectify and repair the non-warranty failure is the customers' full responsibility.

The decision that an issue with a product qualifies as a warranty claim is made at the sole jurisdiction of Euroquip.

No costs incurred will be considered under warranty if repairs are carried out by a party other than a Euroquip Approved Service Agent, unless with prior consent in writing from Euroquip.

It is the responsibility of the purchaser to deliver a product under warranty to the nearest relevant service agent or product reseller. Warranty does not cover call outs, mileage and freight costs.

If a product is repaired under warranty, parts and labour required for the repair will be supplied at no charge. Warranty assessment and repair will be scheduled and executed according to the normal work flow at the service location and depending on the availability of suitable replacement parts.

This warranty policy is an additional benefit and does not affect the legal rights of any end user, reseller or service agent.



Congratulations on your new STRATA product. We are proud to have you as our customer and will strive to provide you with the best service and reliability in the industry. This product is backed by our extensive warranty and world-wide service network. To locate your nearest distributor or service agency visit [www.strata.co.nz](http://www.strata.co.nz), or email us at [customerservice@euroquip.co.nz](mailto:customerservice@euroquip.co.nz)

[www.strata.co.nz](http://www.strata.co.nz)