

# **User's Manual**



***TIG200PACDC***  
***TIG250PACDC***  
***TIG315PACDC***

## PREFACE

Dear Users:

Thank you for your use of the inverter welding machine series products produced by Huayilong. The digital TIG200/250/315 PACDC is an inverter AC/DC pulse square-wave argon arc welding machine manufactured by our company adopting advanced inverting technology. The working principle is to adopt the pulse width modulation (PWM) and high power switch component MOSFET to rectify 50Hz/60Hz power frequency to direct current, invert the current into high frequency up to 100KHz and then reduce the voltage for rectification. The PWM output can support high power DC power supply for welding; due to the switch power inverting technology adopted, the weight and volume of the welding machine decrease greatly and the whole-set conversion rate increases by over 30%.

We recommend you read carefully and understand completely this manual before installation and operation in order to protect the safety of you and others.

Failures	Causes	Solutions
At aluminum welding, the oxidation film can not be broken.	<ul style="list-style-type: none"> <li>The welding position is selected wrongly.</li> <li>The duty cycle is adjusted too low.</li> <li>The secondary inverter field tube is damaged.</li> </ul>	<ul style="list-style-type: none"> <li>Select AC position for aluminum welding.</li> <li>Increase the duty cycle or clear the oxidation film on the surface of the workpiece.</li> <li>Ask professional personnel for repair.</li> </ul>
The current works normally, but no argon flows out.	<ul style="list-style-type: none"> <li>The make-break sound of the solenoid valve exists:                             <ol style="list-style-type: none"> <li>The gas nozzle is jammed</li> <li>The welding gun gas tube is damaged.</li> </ol> </li> <li>No make-break sound of the solenoid valve                             <ol style="list-style-type: none"> <li>The solenoid valve is damaged.</li> <li>The solenoid valve control circuit fails.</li> </ol> </li> </ul>	<ul style="list-style-type: none"> <li>Clear the blockage.</li> <li>Repair or replace the welding gun.</li> <li>Replace the solenoid valve.</li> <li>Ask professional personnel to repair the control panel.</li> </ul>
The tungsten pin is seriously burned.	<ul style="list-style-type: none"> <li>The duty cycle is adjusted too much.</li> </ul>	<ul style="list-style-type: none"> <li>Adjust the duty cycle knob counterclockwise.</li> </ul>
The earth wire is seriously hot.	<ul style="list-style-type: none"> <li>The earth wire is in bad contact</li> </ul>	<ul style="list-style-type: none"> <li>You'd better fix the earth wire onto the work stand with bolts.</li> </ul>

## 6-2 Solutions after Reasons Found

When this device fails or other peripheral components have defects, please contact the local dealer for maintenance.

## CONTENTS

### I. BEFORE USING

1-1. SAFETY NOTICES.....	02
1-2. THE FOLLOWING SAFETY NOTICES SHOULD BE OBSERVED.....	02
1-3. HANDLING, INSTALLATION PLACE....	05
1-3-1. HANDLING.....	05
1-3-2. INSTALLATION PLACE.....	05
1-4. DEVICE PARTS.....	06
1-4-1. APPARATUSES NECESSARY FOR WELDING CONSTRUCTION..	06
1-4-2. CABLE CONNECTION.....	07
1-5. NAMES AND FUNCTION OF VARIOUS PARTS .....	07
1-5-1. POWER SWITCH (BREAKER)....	07
1-5-2. FRONT WIRING PART.....	08
1-5-3. REAR PANEL .....	08
1-5-4. OPERATION PANEL.....	09

### II. TECHNICAL DATA

2-1. TECHNICAL PARAMETERS.....	10
2-2. PRODUCT CONFIGURATION DIAGRAM .....	11
2-3. PRODUCT BREAKDOWN .....	13
2-4. CIRCUIT DIAGRAM.....	14
2-5. WORKING PARAMETERS OF WELDER.....	15

### III. CONNECTION

3-1. CONNECTION.....	16
3-1-1. CONNECTION OF INPUT SIDE.....	16
3-1-2. CONNECTION OF OUTPUT SIDE.....	17

### IV. USE INSTRUCTION

4-1. OPERATION BEFORE AND AFTER WELDING.....	17
4-1-1. PREPARATION BEFORE OPERATION.....	17
4-1-2. WORK AFTER OPERATION... ..	18
4-2. OPERATION PROCESS.....	18
4-2-1. METHOD TO STORE AND CALL PARAMETERS.....	18
4-2-2. WELDING.....	18

### V. CHECK

5-1. DAILY CHECK.....	20
5-1-1. WELDING POWER SUPPLY..	20
5-1-2. CABLES.....	21
5-2. REGULAR CHECK.....	21



### VI. TROUBLES AND TROUBLESHOOTING

6-1. TROUBLES AND TROUBLESHOOTING.....	22
6-2. SOLUTIONS AFTER REASONS FOUND .....	24



## I. BEFORE USE

### 1-1 SAFETY NOTICES

- Before use, please read carefully this manual for your proper use.
- The notices listed in this manual aim at ensuring the safe use of the device and protection measured taken during welding so as to prevent you and others from being harmed and injured.
- When this welding machine is designed and made, the safety has been fully considered; be sure to conform to the notices herein during use; otherwise, major personal accidents such as death or heavy injury may occur.

ALARM SIGN	SIGNAL WORDS
	EXTREME DANGER
	DANGER
	CAUTION

For the welding machine use, adopt the signs shown below to indicate Dos and Don'ts:

	COMPULSORY	MUST DO, SUCH AS GROUND
	FORBIDDEN	MUST NOT DO

The above signs are used in general conditions.

### 1-2 THE FOLLOWING SAFETY NOTICES SHOULD BE OBSERVED:

 **DANGER** In order to avoid major accidents, be sure to obey the following rules:

1. Never use the welding machine for the operation rather than welding.
2. When this welding machine is designed and made, the safety has been fully considered; be sure to pay attention to the notices herein during use; otherwise, major personal accidents such as death or heavy injury may occur.

### ■ Items to be Inspected for Welding Failures

Failures	Causes	Solutions
No action after power-on	<ul style="list-style-type: none"> <li>• No power supply or phase default</li> <li>• Power cable broken</li> <li>• Damaged auxiliary power supply inside the machine</li> </ul>	<ul style="list-style-type: none"> <li>• Check the power supply</li> <li>• Open the housing and check voltage at the air switch</li> <li>• Ask professional personnel for repair or contact the dealer</li> </ul>
High-frequency discharge exists, but there is no current output	<ul style="list-style-type: none"> <li>• Bad earth wire contact</li> <li>• Welding gun cable broken</li> </ul>	<ul style="list-style-type: none"> <li>• Check if the earth wire is reliably connected</li> <li>• Check or replace the welding gun</li> </ul>
The meter can display data, but there is no high-frequency discharge sound or abnormal indication.	<ul style="list-style-type: none"> <li>• The welding gun switch, wire and aviation socket is broken or in bad contact.</li> <li>• The discharge nozzle is short circuited or it is placed far away.</li> <li>• The aviation socket is installed wrongly.</li> </ul>	<ul style="list-style-type: none"> <li>• Connect two contacts of 2-core aviation socket with a screwdriver. If discharge sound appears, it will indicate the welding gun goes wrong.</li> <li>• Adjust the distance of the discharge nozzle</li> <li>• When using the pedal unit or welding gun switch, it is required to install the aviation plug onto the 2-core socket corresponding with the panel.</li> </ul>
The current output exists, but it cannot be adjusted.	<ul style="list-style-type: none"> <li>• The hand manual/pedal switch is in a wrong position.</li> <li>• The potentiometer inside the pedal unit is damaged.</li> </ul>	<ul style="list-style-type: none"> <li>• When using the pedal unit, place the switch on the position of "ON".</li> <li>• Replace the potentiometer.</li> </ul>
The manual adjustment is normal, but the pedal unit reacts abnormally.	<ul style="list-style-type: none"> <li>• The microswitch inside the pedal unit is damaged</li> <li>• The linear sliding potentiometer inside the pedal unit is easily worn out.</li> </ul>	<ul style="list-style-type: none"> <li>• Replace the microswitch.</li> <li>• Replace 1K linear sliding potentiometer.</li> </ul>
The abnormality indicator is on.	<ul style="list-style-type: none"> <li>• The momentary overcurrent protection acts.</li> <li>• Short circuit is caused by too much dust inside.</li> <li>• Some component inside is damaged.</li> </ul>	<ul style="list-style-type: none"> <li>• Power off; power on again after the indicator is out.</li> <li>• Open the housing and remove dust with compressed air.</li> <li>• Ask professional personnel for repair or contact the dealer.</li> </ul>

## ■ Check contents

In addition to the check items below, the user may add more check items according to his/her actual situation.

- Remove dust inside  
Remove the cover, remove the dirt or foreign matters hard to be blown away. Use the compressed air without water contained (dry air) to blow the accumulated dust inside away.
- Routine Check  
Remove the cover and be sure to pay attention to the check on the following items and non-routine items.  
Check if there is rare odor, fading or overheat damage traces and the connection points are loose.
- Cable Check  
Please mainly check such non-routine check items (supplementary fastening, etc) as the earth wire, cables, etc.

3. With regard to the construction of the power source at input side, the selection of the installation place, the use, the keeping and configuration of high-pressure gas, the keeping of workpieces and the waste disposal after welding, etc, be sure to conform to related regulations and the internal standards of the company.
4. Never enter the welding operation place for unrelated personnel.
5. For people using the heart pacemaker, never be close to the welding machine during stay around the welding operation place without the doctor's permission.
6. Ask personnel with professional qualifications or professionals to install, overhaul and maintain the welding machine.
7. In order to ensure safety, please properly understand the contents in this manual and ask personnel with safe application knowledge and techniques to operate the welding machine.



**DANGER**

To avoid electric shock, be sure to follow the instructions below.



The touch with the live positions out of the secondary electrode may cause electric shock or burning.

1. Never touch live parts.
2. Ask related electrical personnel to earth the welder and parent material as per related regulations.
3. During installation and servicing, the power supply of the distribution box must be first turned off and the operation can be conducted in 5 minutes. Because the capacitor is rechargeable, even if the power is shut off, never work before you make sure the capacitor is not charging.
4. Never use the cable without enough capacity and with insulation sleeve damaged to cause the conductor to be exposed.
5. Ensure the insulation of the cable connection.
6. Never use the welder with the housing removed.
7. Use dry insulation gloves.
8. Use safety grille during work at height.
9. Conduct regular maintenance and servicing; do not use it until damaged part is repaired.
10. When it is not in use, turn off all input power supplies.
11. Use the anti-electrical shock function when using the AC arc welder in narrow places or at height.



**DANGER**

In order to prevent welding fume and gas harming you and others, always use protective tools.



- \* Welding fume and gas may harm health.
- \* In narrow place, welding may cause suffocation due to oxygen shortage.

1. In order to prevent gas poisoning, suffocation, etc, please use only the specified facilities and breath protective tools.

## VI TROUBLES AND TROUBLESHOOTING

### 6-1 TROUBLES AND TROUBLESHOOTING

<b>WARNING</b>		Any live electrical parts touched may cause fatal electric shock or serious burns. In order to prevent such personal accidents as electric shock and burn, be sure to follow the instructions below:
----------------	--	--

- Troubleshooting must be completed by personnel with professional competency or competent personnel.
- Before operation, be sure to turn off the power supplies of this product, distribution box (user's equipment), related devices (external devices connected with the input terminal); and due to the discharge of the capacitor, be sure not to operate until the welding power supply is turned off for at least 5min.

<b>Caution</b>	<ul style="list-style-type: none"> <li>• When the power is automatically off, never power on again. Be sure to contact the supplier.</li> <li>• The power switch is a circuit breaker. In case of over-current due to whatever reason, the power will be automatically off; never power on again (power-on is rather dangerous before the trouble causing over-current has not been removed).</li> </ul>
----------------	--

2. In order to prevent dust harm and poison such as welding smoke, etc, be sure to use the specified local exhaust equipment and breath protective devices.
3. In case of welding on the bottom of cases, boilers, vessels, etc, as such gases heavier than air as CO<sub>2</sub>, Air, etc will settle on the bottom, therefore, make sure sufficient gas exchange and breath protective tools are available.
4. When working in the narrow place, please accept the check of the supervisor, make sure sufficient air exchange is available and prepare the breath protective devices.
5. Do not conduct welding in degreasing, cleaning and spraying areas.
6. When welding the steel plate with plating or coating, harmful fume and gases may occur, so always use breath protective tools.



## DANGER

In order to prevent fire, explosion, burst, etc, be sure to follow the following regulations:



- \* Splashes and hot parent materials having just been welded may cause fire.
- \* When the point with bad cabling, the side current loop of such parent materials as steel bar, etc have incomplete touch, electric heating may occur and thus cause fire.
- \* Do not weld on the container with flammables, otherwise, explosion may occur.
- \* Do not weld the sealed container, such as trough (case), tube, etc, otherwise, burst may occur.

1. Do not place flammables in the welding place.
2. Do not weld near flammable gases.
3. Do not keep the hot parent material having just been welded near flammables
4. When welding parvis, ground or wall, remove the flammables on the back.
5. Make sure the cable connection point is well insulated.
6. The cable on the parent material shall close to the welding point as possible.
7. Do not weld such units as gas pipe, sealed trough, etc with gases.
8. Always place some extinguishers near the welding area to prevent fire.



## CAUTION

In order to prevent welding arc, splash, welding slag, noise, etc from harming you and others, please use the specified protective tools.



- \* Arc may cause eye inflammation or skin burning, etc
- \* Splash and welding slag can burn your eyes and your skin.
- \* Noise may affect listening.

1. When welding or monitoring the welding, please use protectors with enough opacity.
2. Please wear protective glasses.
3. Please use welding protectors welding such as leather protective gloves, long-sleeve clothes, foot protectors and aprons.
4. Install protective barriers around the welding place in order to prevent arc from harming others.
5. In case of large noise, be sure to use sound-insulated devices.

## 5-1-2 CABLES

ITEMS	CHECK POINTS	RMKS
Grounding cable	<ul style="list-style-type: none"> <li>• Check if every earth wire (for this device and parent metal grounding) falls off; and check if the connections are safe and reliable.</li> </ul>	In order to avoid personal electric shock accidents, be sure to conduct related checks.
Cable	<ul style="list-style-type: none"> <li>• Check if the cable insulation layer is worn and has other damages, if the conductive components are exposed.</li> <li>• Check if the cable suffers abnormal exterior force</li> <li>• Check if the connection of the cable connecting with the parent metal is reliable and firm.</li> </ul>	In order to ensure the arc safety and stability, be sure to adopt proper methods to conduct the check according to the condition of the operation site; daily check should be simple while regular check should be careful.

## 5-2 REGULAR CHECK



Any live electrical parts touched may cause fatal electric shock or serious burns. In order to prevent such personal accidents as electric shock and burn, be sure to follow the instructions below:

- In order to ensure safety, the regular check must be completed by personnel with professional competency or competent personnel.
- Before check, be sure to turn off the power supplies of this product, distribution box (user's equipment), related devices (external devices connected with the input terminal); and due to the discharge of the capacitor, be sure not to operate until the welding power supply is turned off for at least 5min.



In order to prevent the semiconductor and P plate from being damaged by static, please follow the instructions below:

- Before touching the conductor of the cables and P plate inside the device, you may remove the static in advance via touching the housing metal position with your hand, etc
- In order to maintain the performance of this product for a long time, the regular check is required.
- Be sure to conduct the regular check very carefully, including the inspection and cleaning of the product inside.
- The regular checks should be generally conducted once every 6 months. (However, if much fine dirt exists in the welding place, or much oily smoke and fume exists there, the regular check should be conducted once every 3 months).



(3-6 months) conduct an internal check for the welding power supply. For details, please refer to the user manual.			
	1	2	3
Regular check Period	//	//	//
Year/Month/Day	//	//	//

You may make the label and fill in the date for the regular check.

	<p><b>Warning</b></p> <p>When you conduct welding first time, you are required to hold the switch for seconds before welding until all air in the air passage is cleared. After welding, argon will still flow out within seconds, which is designed to ensure the welding spot is still protected before cooling. Therefore, during use, after the arc goes out, the welding gun can not be removed until the welding position is still protected for some time.</p>
---	---

## V CHECK

### 5-1 DAILY CHECK

		<p>Any live electrical parts touched may cause fatal electric shock or serious burns. In order to prevent such personal accidents as electric shock and burn, be sure to follow the instructions below:</p>
<p>During daily check, be sure to turn off the power supplies of this product and distribution box (user's equipment). (except the appearance check not requiring touching or approaching live parts.)</p>		

- It is crucial to conduct daily check for high-performance use and safe operation of the machine.
- Conduct the inspection according to the check items shown in the following table; when necessary, clean or replace such items.

#### 5-1-1 WELDING POWER SUPPLY



ITEMS	CHECK POINTS	RMKS
Front panel	<ul style="list-style-type: none"> <li>• Check if every component is damaged or loose.</li> <li>• Check if the lower quick socket is loose.</li> </ul>	The lower quick socket is as regular check item. If defect occurs, it is necessary to check the inside, fasten the parts or replace the components where necessary.
Rear panel	<ul style="list-style-type: none"> <li>• Check if the air intake of the cooling fan has foreign objects sticking to.</li> </ul>	
Routine	<ul style="list-style-type: none"> <li>• Power on, and then check if the appearance has fading or too hot traces.</li> <li>• Check if the cooling fan has stable operation sound.</li> <li>• Check if the cooling fan takes in air from the air intake, if odor, abnormal vibration or noise (especially during welding) occurs</li> </ul>	In case of defects, it is necessary to check the inside of the device.
Top plate Bottom plate Side panel	<ul style="list-style-type: none"> <li>• When the machine cover is installed onto the housing, check if it is loose.</li> <li>• Check if bolts are loose.</li> </ul>	In case of defects, it is necessary to replace or fasten components, etc as required.

## 1-3 HANDLING, INSTALLATION PLACE

### 1-3-1 HANDLING

	<p><b>CAUTION</b></p> <p>Keep flat during transport; properly protect the welding machine to prevent scratches, bruises, etc.</p>
---	---

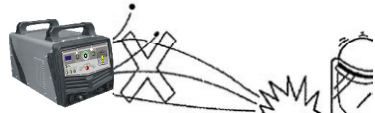
### 1-3-2 INSTALLATION PLACE

<p>Place the welding machine in the rainproof room with no direct sunshine, low humidity and little dust (room temperature 10°C~40°C).</p> 	<p>Any conductive foreign object can not enter the welding power supply.</p> 
<p>Keep the welding power supply over 20cm away from the wall. Two welding machines should be over 30cm apart when placed in parallel.</p> 	<p>Conduct the welding at the place without wind (use the wind shield, etc).</p> 

	<p><b>CAUTION</b></p> <p>This product should be used indoor; it's recommended not to use it in the place which may suffer from rain</p>
<p>In case this product is soaked with rain, rain drops may fall into the power supply inside; at this time, a serious accident may occur. Therefore, ask professional personnel to conduct related check and maintenance.</p>	

## 1-4 Device Parts

### 1-4-1 Apparatuses Necessary for Welding Construction (TIG315PACDC)

NO	Standard products needed	RMKS	NO	Standard products needed	RMKS
①	TIG welding gun	WP-18	④	Distribution box	Three-phase 380V
②	Workpiece	—	⑤	Pedal switch	—
③	Earth clamp	300A	⑥	Flow adjuster	—



Notice

The connection diagram of the welder is shown below. Be sure to use this welding machine with the specified welding gun, earth clamp together; otherwise, it will affect the welding performance and may damage the machine.

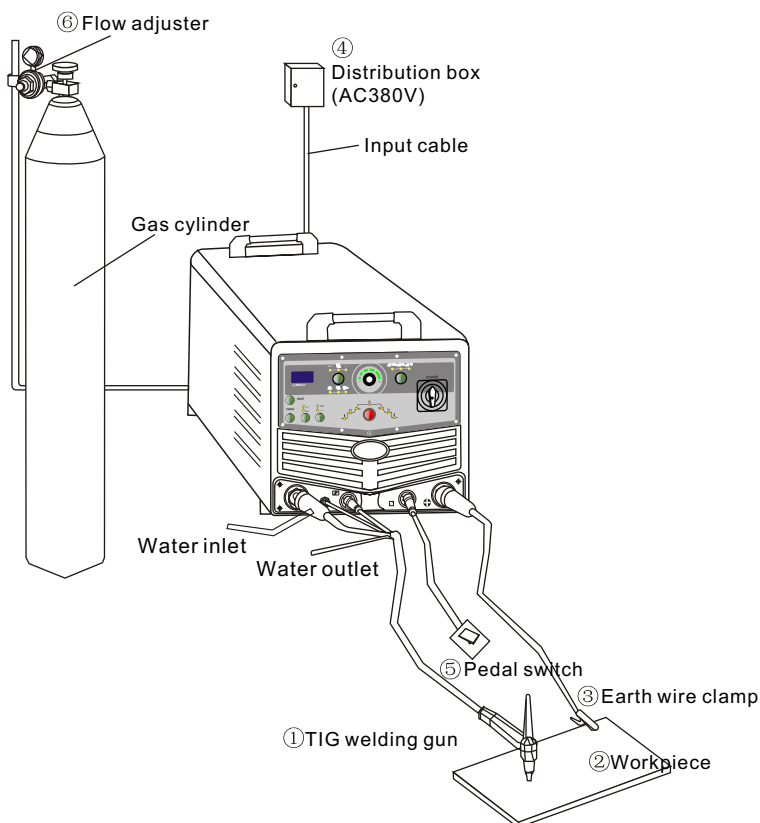

- After regulating the welding current, save such welding parameter as unit n; for the next use, you may directly call the parameters in the storage unit n.
- Please note the rated welding current and duty cycle; Do not use the welding machine under overload.
- After the welding is over, turn off the power switch and then disconnect the input power.

#### ■ DC TIG Welding

- Connect the welding machine to the input power supply and power the welding machine on. In such case, power on the machine and let it have a self-check; and the screen will display: Full display->HYL->Model such as 250-> Enter the previous welding status.
- Press the TIG/MMA function selector switch, then the DC TIG indicator will be on and the welding machine will change into the DC TIG status.
- According to the requirement, press the Pulse/DC shift key. When the Pulse indicator is on, press the function shift key ⑳. When the Base Current, Duty Cycle and Pulse Frequency indicators are on respectively, adjust the knob ㉑ to respectively adjust the above parameters so as to achieve the welding effect required by the user.
- Press the parameter setup selector key ㉒ to set welding parameters such as foreblow time, arc striking current, rise time, given current, fall time, arc stopping current, afterblow time, etc; with the regulation knob ㉑, you may respectively adjust the above parameters. For details, see Section 2-5 Welding Condition Table.
- Press the 2T/4T selector key to choose 2T or 4T.
- In welding, you may adjust the welding parameters. The 2T/4T and the welding mode cannot be switched.
- After regulating the welding current, save such welding parameter as unit n; for the next use, you may directly call the parameters in the storage unit n.
- After the welding is over, turn off the power switch and then disconnect the input power.

#### ■ AC TIG Welding

- Connect the welding machine to the input power supply and power the welding machine on. In such case, power on the machine and let it have a self-check; and the screen will display: Full display->HYL->Model such as 250-> Enter the previous welding status.
- Press the TIG/MMA function selector switch, then the ACTIG indicator will be on and the welding machine will change into the AC TIG status.
- According to the requirement, press the Pulse/DC shift key. When the Pulse indicator is on, press the function shift key ⑳. When the Base Current, Duty Cycle and Pulse Frequency indicators are on respectively, adjust the knob ㉑ to respectively adjust the above parameters so as to achieve the welding effect required by the user.
- Press the parameter setup selector key ㉒ to set welding parameters such as foreblow time, arc striking current, rise time, given current, fall time, arc stopping current, afterblow time, etc; with the regulation knob ㉑, you may respectively adjust the above parameters. For details, see Section 2-5 Welding Condition Table.
- Press the 2T/4T selector key to choose 2T or 4T.
- In welding, you may adjust the welding parameters. The 2T/4T and the welding mode cannot be switched.
- After regulating the welding current, save such welding parameter as unit n; for the next use, you may directly call the parameters in the storage unit n.
- After the welding is over, turn off the power switch and then disconnect the input power.



- After connection is over, check if the following connections are completed.  
Parent metal: Earth wire  
Welding machine: Grounding terminal earth
- Power on  
Turn the switch of the power distribution box on and then turn on the switch of this device

## 4-1-2 WORK AFTER OPERATION

- Power off  
Firstly power off this device and then the power distribution box.



In order to make this product fully cool down, be sure to disconnect the power supply after over 5min when the welding operation is finished.

## 4-2 OPERATION PROCESS

### 4-2-1 METHOD TO STORE AND CALL PARAMETERS

- Parameter Storage
  - Press the parameter storage function key [SAVE key] to enter the storage status, then the screen will display "SA..n";
  - With the regulation knob ⑨, select the storage unit n whose scope is 0-9.
  - Press the parameter storage function key again; when the welding parameters are to be saved into the target storage unit n, then the screen will display "to.n"; after flashing 3s, n will return to the status before storage.
- Parameter Call
  - Press the parameter call function key [PROG key] to enter the call status, then the screen will display "rd..n";
  - With the regulation knob ⑨, select the saved unit n
  - Press the parameter call function key again, then the welding parameters of the storage unit n will be read and cover the current status, and the screen will display Fr.n; after flashing 3s, n will return to the storage status.
  - In the process of stored parameter call, if failing to press the key to confirm, press any other key or trigger the gun to give up such operation and back to the welding status.

### 4-2-2 WELDING

- MMA Welding
  - Connect the welding machine to the input power supply and power the welding machine on. In such case, power on the machine and let it have a self-check; and the screen will display: Full display->HYL->Model such as 200-> Enter the previous welding status.
  - Press the TIG/MMA function selector switch, then the MMA indicator will be on and the welding machine will change into the MMA status.
  - With the regulation knob ⑨, select a proper welding current. The experimental expression for welding current selection is  $I=40D$ , where, D is the diameter of the used welding rod in mm.

## 1-4-2 Cable Connection



Waterproof measures

When this welding machine is used under the circumstance with water, be sure to adopt waterproof measures in the cable connection position. (If water enters the connection position, the insulation resistance may decrease or even the short circuit may occur between connecting lines, thus causing failures.

Be sure to pay attention to the following when connecting cables: The length and wire diameter (sectional area) should be selected properly; otherwise, the welding performance will decrease due to the voltage drop on the cable.



It is forbidden to plug and unplug any cable or connector being used, this operation will endanger personal safety and cause severe damage to the equipment.

## 1-5 Names and Function of Various Parts

### 1-5-1 Power Switch (Breaker)



About Power Supply

Under the circumstance that the electric generator is used, be sure to disconnect the power supply when starting the generator.

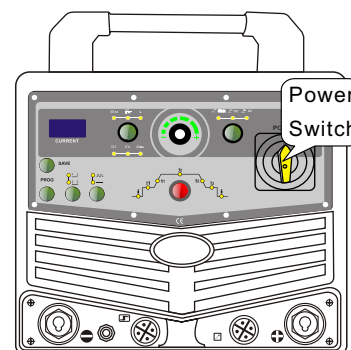

Connection and disconnection operation of the power switch:

- Power-on state when the power switch is at "1" point.
- Power-off state when the power switch is at "0" point.

## 1-5-2 Front Wiring Part

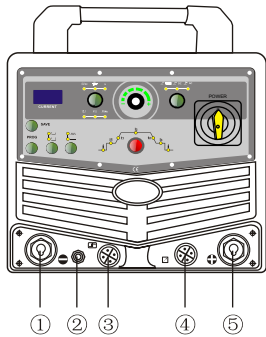

①	Welding gun connector • Reliably connected to the argon arc welding gun
②	Gas outlet • Connected to the gas tube of the argon arc welding gun
③	Aviation socket • Connected to the welding gun control switch cable
④	Aviation socket • Connected to the pedal switch cable
⑤	Parent metal connector • Reliably connected to the parent metal cable

## 1-5-3 Operation Panel

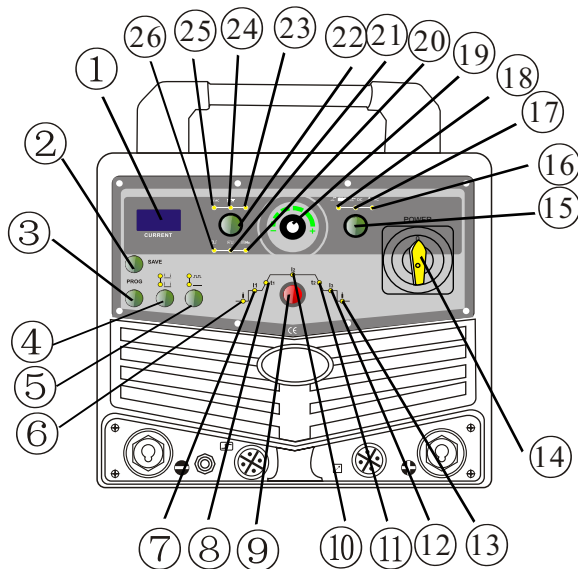

## 3-1-2 CONNECTION OF OUTPUT SIDE

Connection of parent metal cable  
• Please use the attached connector to connect the parent metal cable to the positive OUT socket.

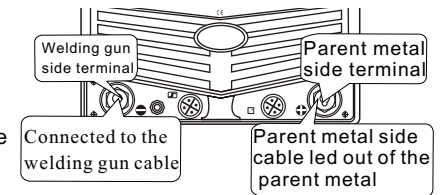

Connection of the cable on the side of the electrode holder  
• Please use the attached connector to connect the electrode holder cable to the negative OUT socket.

Connection of the aviation socket side  
• Please use the attached plug to connect the cable of the manual switch to the aviation socket.

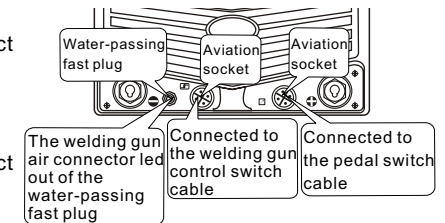

Connection of water-passing fast plug  
• Please use the attached plug to connect the air connector of the welding gun to the water-passing fast plug.

## IV. USE INSTRUCTIONS



### 4-1 OPERATION BEFORE AND AFTER WELDING

#### 4-1-1 PREPARATION BEFORE OPERATION

<b>DANGER</b>		<p>During operation, be sure to use protective devices or air exhaust system to protect you and others from being damaged due to the welding fume and ensure sufficient oxygen supply.</p> <ul style="list-style-type: none"> <li>• If the welding operation is conducted in small and badly ventilating area, it may lead to the oxygen deficiency and even make people suffocated.</li> <li>• The fume intake during welding is very harmful to the human body; be sure to provide fume exhaust and air exchange methods or use the respiratory protective device.</li> </ul>
<b>WARNING</b>		<p>During operation, be sure to use protective devices to protect you and others from being damaged by the arc, splash, noise, etc caused by welding.</p> <ul style="list-style-type: none"> <li>• Wear the special protective clothes, such as gloves, safety boots, etc to protect eyes and the exposed skin.</li> <li>• Please prepare shades or use protective masks with shadow shield.</li> </ul>

## III. CONNECTION

### 3-1 CONNECTION

 DANGER		Any live parts touched may cause electric shock accidents. In order to prevent such accidents, be sure to follow the instructions below:
<ul style="list-style-type: none"> <li>The control panel shall be operated by the personnel who have qualifications or know the circuit of this welding machine.</li> <li>Before operation, the operator must disconnect the power switch of this welding machine, the switch of the power distribution box supplying electricity to this welding machine, the distribution switch of other electric appliances which have the wiring relation (external terminal, etc) with this welding machine. The operation can not be conducted until the capacitance of this welding machine is discharged for 5min.</li> </ul>		

 Warning	In order to prevent the control panel from being damaged due to static electricity when such control panel is touched. Be sure to follow the instructions below.
<ul style="list-style-type: none"> <li>Never touch other unrelated parts.</li> <li>Before operation, be sure to make your hand fully contact the metal housing so as to ensure the static electricity on you can be discharged to the ground.</li> </ul>	

#### 3-1-1 CONNECTION OF INPUT SIDE

Connection of earth wire

 CAUTION	As the tap water pipe and reinforced bars for houses have no full grounding, never connect the earth wire to such places.
---	---

- Connect one end of the earth wire to the rear grounding terminal
- Reliably ground the other end of the earth wire. Connect the air faucet with the air pipe reliably.

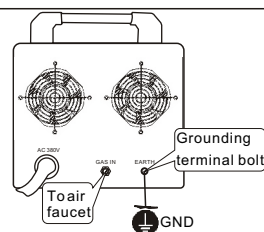

Connection of input power supply

 DANGER	Please configure one power distribution box for every welding machine.
--	--

- Connect the cable on the input side to the output terminal of the switch of the power distribution box.

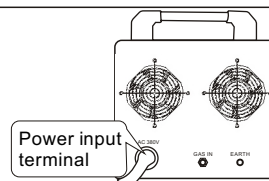

No.	Name and Function	No.	Name and Function	No.	Name and Function
①	LED digital tube	②	Parameter storage key	③	Parameter call key
④	2T/4T selector switch	⑤	Pulse/DC selector switch	⑥	Foreblow time regulation indicator
⑦	Initial current regulation indicator	⑧	Rise time regulation indicator	⑨	Welding parameter setup switching key
⑩	Given current regulation indicator	⑪	Fall time regulation indicator	⑫	Fall current regulation indicator
⑬	Afterblow time regulation indicator	⑭	Power switch	⑮	TIG/MMA selector switch
⑯	AC TIG welding indicator	⑰	DC TIG welding indicator	⑱	MMA welding indicator
⑲	Parameter regulation knob	⑳	Pulse frequency regulation indicator	㉑	Duty cycle regulation indicator
㉒	Function selector switch	㉓	Current regulation indicator	㉔	Cleanup width indicator
㉕	AC frequency regulation indicator	㉖	Base value current regulation indicator		

#### 1-5-4 Rear Panel

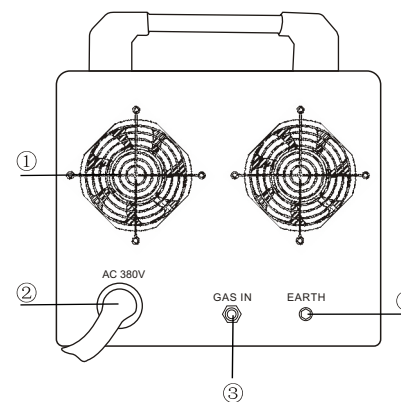

①	<b>Fan</b> <ul style="list-style-type: none"> <li>Never put any wind-shielding object nearby</li> </ul>
②	<b>Power input terminal</b> <ul style="list-style-type: none"> <li>When the power incoming wire is connected, in order to prevent it from being loosened, be sure to have reliable connection.</li> </ul>
③	<b>To air faucet</b> <ul style="list-style-type: none"> <li>Make sure it keeps smooth.</li> </ul>
④	<b>Grounding terminal</b> <ul style="list-style-type: none"> <li>Please use a reliable grounding method.</li> </ul>

## 二、Technical Data

### 2-1 Technical Parameters

Model	TIG200PACDC		TIG250PACDC		TIG250PACDC		TIG315PACDC	
Power voltage (V)	Single- phase 220V-240V				Three- phase 380V-420V			
Frequency (HZ)	50/60		50/60		50/60		50/60	
	TIG	MMA	TIG	MMA	TIG	MMA	TIG	MMA
Rated input power capacity (KVA)	4.6	6.2	6.3	8.5	6.3	8.5	9	11
Output current scope (A)	10-200	10-180	10-250	10-230	10-250	10-230	10-300	10-280
Output voltage scope (V)	10.4-18	20.4-27.2	10.4-20	20.4-29.2	10.4-20	20.4-29.2	10.4-22	20.4-31.2
No-load voltage (V)	62		40		40		45	
Foreblow time (S)	0-1		0-1		0-1		0-1	
Load duration rate (%)	60		60		60		60	
Cleanup width (%)	20-80		20-80		20-80		20-80	
Damping time (S)	0-10		0-10		0-10		0-10	
Afterblow time (S)	1-10		1-10		1-10		1-10	
Base value current (%)	10-90		10-90		10-90		10-90	
Pulse frequency (Hz)	0.5-300		0.5-300		0.5-300		0.5-300	
Pulse duty cycle (%)	10-90		10-90		10-90		10-90	
ARC-starting	HF		HF		HF		HF	
Power factor (cosφ)	0.93		0.93		0.93		0.93	
Efficiency (%)	85		85		85		85	
Housing protection class	IP21S		IP21S		IP21S		IP21S	
Insulation class	F		F		F		F	
Total weight (kg)	28		32		32		32.8	
External dimensions (mm)	550×390×430		550×390×430		550×390×430		550×390×430	

### 2-5 WORKING PARAMETERS OF WELDER

Below is the parameter selection table of manual tungsten electrode/argon welding of thin stainless steel sheets (for reference only)

Sheet thickness (mm)	Connector form	Tungsten electrode diameter(mm)	Welding wire diameter(mm)	Current category	Welding current (A)	Argon flow (L/min)	Welding speed (cm/min)
1.0	Butt joint	2	1.6	DC straight connection	7~28	3~4	12~47
1.2		2	1.6		15	3~4	25
1.5		2	1.6		5~19	3~4	8~32

Below is the parameter selection table of manual tungsten electrode/argon welding of titanium and its alloy (for reference only)

Sheet thickness (mm)	Groove form	Number of welding layers	Tungsten electrode diameter	Welding diameter	Welding current	Argon flow (L/min)			Nozzle aperture
0.5	I-shaped	1	1.5	1.0	30~50	8~10	6~8	14~16	10
1.0		1	2.0	1.0~2.0	40~60	8~10	6~8	14~16	10
1.5		1	2.0	1.0~2.0	60~80	10~12	8~10	14~16	10~12
2.0		1	2.0~3.0	1.0~2.0	80~110	12~14	10~12	16~20	12~14
2.5		1	2.0~3.0	2.0	110~120	12~14	10~12	16~20	12~14
3.0	Y-shaped	1~2	3.0	2.0~3.0	120~140	12~14	10~12	16~20	14~18
4.0		2	3.0~4.0	2.0~3.0	130~150	14~16	12~14	20~25	18~20
5.0		2~3	4.0	3.0	130~150	14~16	12~14	20~25	18~20
6.0		2~3	4.0	3.0~4.0	140~180	14~16	12~14	25~28	18~20
7.0		2~3	4.0	3.0~4.0	140~180	14~16	12~14	25~28	20~22
8.0	3~4	4.0	3.0~4.0	140~180	14~16	12~14	25~28	20~22	
10	Double Y-shaped	4~6	4.0	3.0~4.0	160~200	14~16	12~14	25~28	20~22
20		12	4.0	4.0	200~240	12~14	10~12	20	18
22		12	4.0	4.0~5.0	230~250	15~18	18~20	18~20	20
25		15~16	4.0	3.0~4.0	200~220	16~18	20~26	26~30	22
30		17~18	4.0	3.0~4.0	200~220	16~18	20~26	26~30	22

Below is the parameter selection table of manual tungsten electrode/argon welding of stainless steel

Sheet thickness (mm)	Current(A)		Duration (S)		Pulse frequency (HZ)	Welding speed (cm/min)
	Pulse	Basic value	Pulse	Basic value		
0.3	20~22	5~8	0.06~0.08	0.06	8	50~ 60
0.5	55~60	10	0.08	0.06	7	55~ 60
0.8	85	10	0.12	0.08	5	80~100

2-4 Circuit Diagram

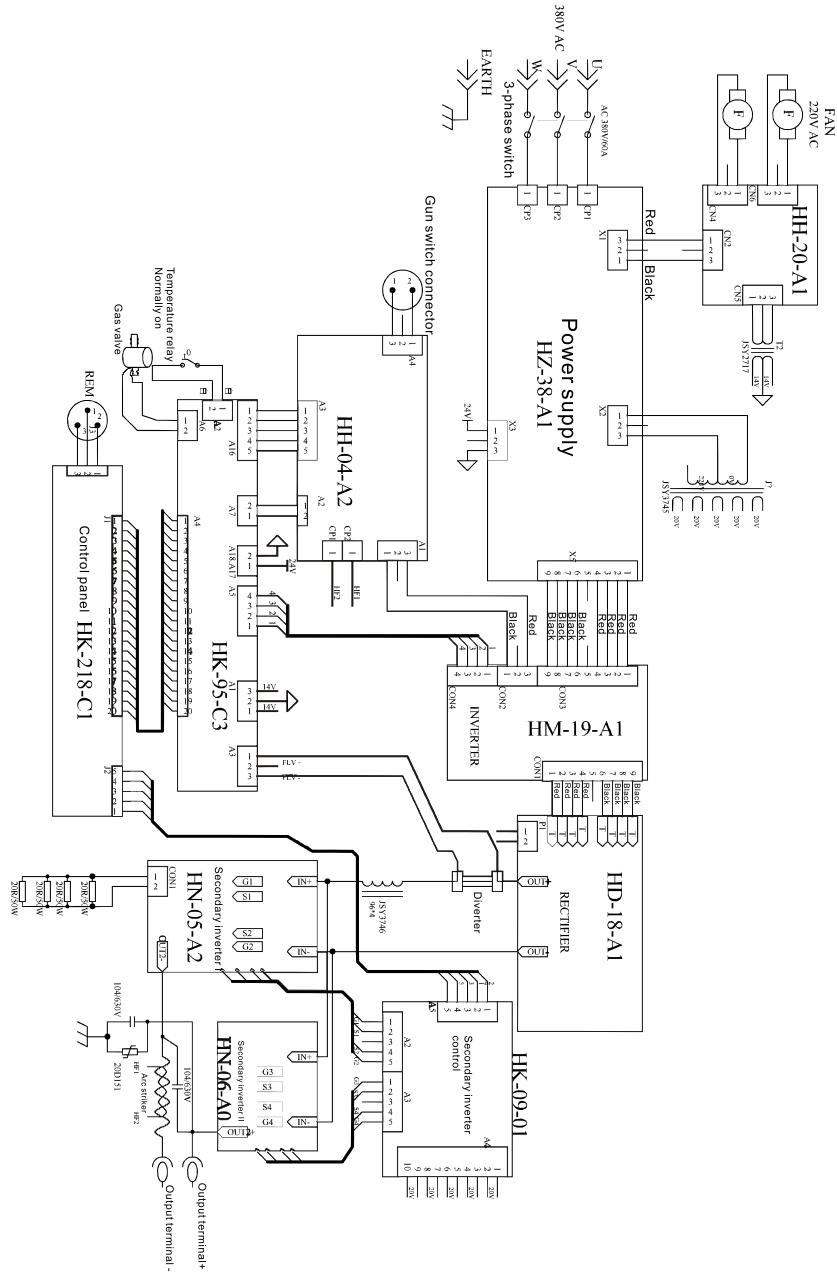

2-2 Product Configuration Diagram

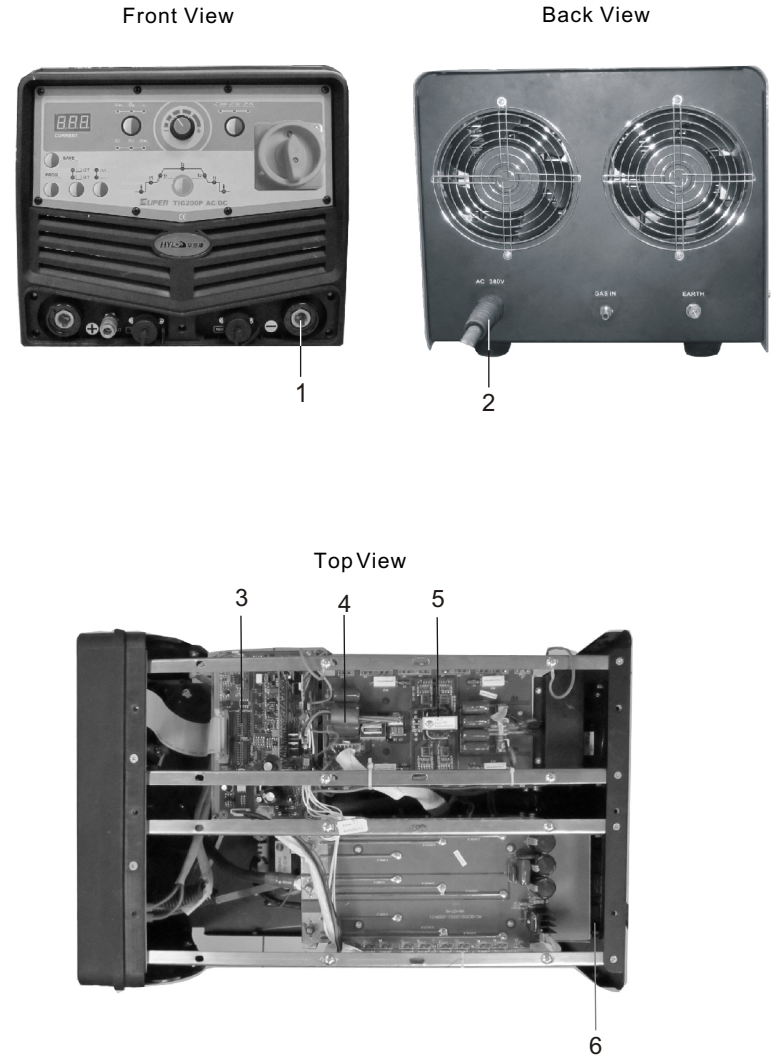

2-3 Product Breakdown

Left View

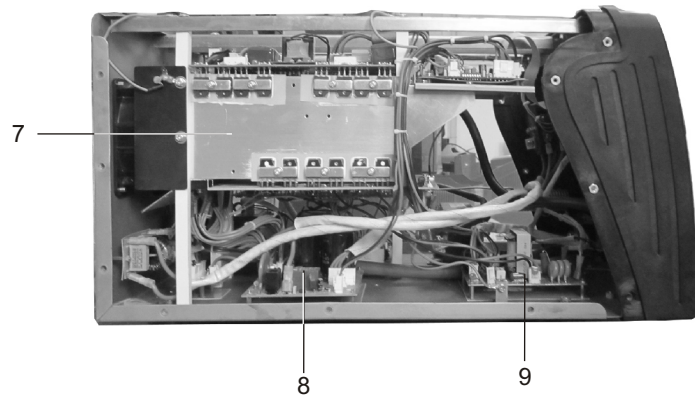

Right View

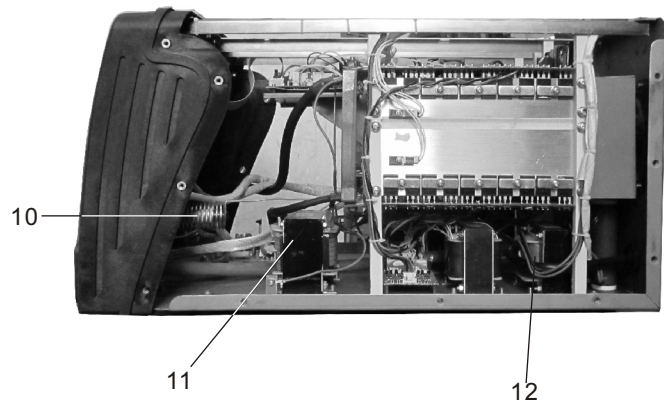

SN	Name	RMKS
1	Fast socket	Onnects with the workpiece.
2	Self-locking wire buckle	Fix the input cable
3	Control panel	Core control circuit, PWM adjustment and MOSFET drive control available
4	CBB capacitor	Provides load current
5	Drive module	Drives the connection/disconnection of FET
6	Fan	Used to cool heating parts inside
7	Radiator	Reduces the temperature of the heating component inside the machine
8	Bottom plate	Rectifies and filters.
9	Arc striking plate	Controls HF
10	Arc-striking coil	Induces high-frequency voltage and penetrates air arcstriking
11	Reactor	Smoothens wave and continues current
12	Power frequency transformer	Provides power for the drive plate.