

Operating Instructions and Manual

Kawashima

powered by **YAMAHA MZ80 ENGINE**



perfect-power
Guaranteed Pure
Sine Wave

PRO2000i
INVERTER GENERATOR

Kawashima

powered by **YAMAHA MZ80 ENGINE**

We Appreciate Your Business.

Thank you and congratulations for choosing Kawashima.

You have invested in a machine that will last a lifetime if you follow strictly the maintenance and care guidelines set out in this manual.

This Operating Manual has been designed to instruct you on the correct use and operation of your Kawashima product. Your satisfaction with this product and its safe operation is our ultimate concern. Therefore please take the time to read the entire manual, especially the Safety Precautions. They will help you to avoid potential hazards that may exist when working with this product.

WARNING!

READ AND UNDERSTAND ALL SAFETY PRECAUTIONS IN THIS MANUAL BEFORE OPERATING. FAILURE TO COMPLY WITH INSTRUCTIONS IN THIS MANUAL COULD RESULT IN PERSONAL INJURY, PROPERTY DAMAGE, AND/ OR VOIDING OF YOUR WARRANTY. KAWASHIMA WILL NOT BE LIABLE FOR ANY DAMAGE BECAUSE OF FAILURE TO FOLLOW THESE INSTRUCTIONS.

Table of Contents

1. SECTION 1: SAFETY INSTRUCTIONS AND WARNINGS	1-1
1.1 Symbol Usage.....	1-1
1.2 General Safety Precautions	1-2
2. SECTION 2: CONTROLS AND FEATURES	2-1
2.1 Generator	2-1
2.2 Control Panel	2-2
2.3 Control Functions	2-3
3. SECTION 3: GETTING STARTED	3-1
3.1 Unpack the Generator	3-1
3.2 Adding Engine Oil	3-1
3.3 Adding Fuel	3-2
3.4 Starting the Engine	3-4
3.5 Stopping the Engine	3-6
4. SECTION 4: ELECTRICAL CONNECTION	4-1
4.1 Capacity	4-1
4.2 Power Maintenance	4-1
4.3 Connecting Electrical Loads	4-1
4.4 Battery Charging.....	4-2
4.5 Wattage Reference Guide.....	4-3
5. SECTION 5: MAINTENANCE	5-1
5.1 Periodic Maintenance	5-1
5.2 Spark Plug Maintenance	5-2
5.3 Engine Oil Replacement	5-3
5.4 Air Filter Maintenance	5-4
5.5 Muffler Screen & Spark Arrestor Maintenance	5-5
5.6 Fuel Filter Maintenance	5-6
6. SECTION 6: STORAGE	6-1
6.1 Long Term Storage	6-1
7. SECTION 7: TROUBLESHOOTING AND SPECIFICATIONS	7-1
7.1 Troubleshooting Diagram	7-1
7.2 Fuel Filter Maintenance	7-2
7.3 Specifications	7-3

SECTION 1:

SAFETY INSTRUCTIONS AND WARNINGS

1.1 Symbol Usage

This manual contains important information that you need to know and understand in order to assure YOUR SAFETY and PROPER OPERATION OF EQUIPMENT. The following symbols help you recognize this information. Please read the manual and pay attention to these sections.

Save These Important Safety Instructions!

Read and understand all of these safety instructions. Be sure to retain them for future use.



WARNING!

WARNINGS INDICATE A CERTAINTY OR STRONG POSSIBILITY OF PERSONAL INJURY OR DEATH IF INSTRUCTIONS ARE NOT FOLLOWED.



CAUTION:

CAUTIONS INDICATE A POSSIBILITY OF EQUIPMENT DAMAGE IF INSTRUCTIONS ARE NOT FOLLOWED PROPERLY.



Note:

Notes give helpful information

Gasoline powered and electrical generating products can cause serious injury or death, or damage to other equipment or property, if the operator does not strictly observe all safety rules and take precautionary actions.

1.2 General Safety Precautions



WARNING!
FAILURE TO FOLLOW THESE INSTRUCTIONS CAN RESULT IN SEVERE INJURY OR DEATH.



CAUTION:
FAILURE TO FOLLOW THESE INSTRUCTIONS CAN ALSO RESULT IN DAMAGE TO THE EQUIPMENT AND/OR THE ITEM YOU ARE WORKING ON OR WITH.

Carbon Monoxide

- Carbon Monoxide is an odourless and colourless gas. Breathing exhaust that contains this poisonous gas can cause unconsciousness and may lead to death.
- The engine exhaust from this product contains chemicals recognized by the state of California to cause cancer, birth defects, or other reproductive harm.
- When this tool is running, ensure that the area is well ventilated. Never run the engine in an enclosed area. Run the engine in an open area or with an exhaust evacuation system in an enclosed area.
- NEVER use a generator inside homes, garages, crawlspaces, or other partially enclosed areas. Deadly levels of carbon monoxide can build up in these areas. Using a fan or opening windows and doors does NOT supply enough fresh air.
- ONLY use a generator outdoors and far away from open windows, doors, and vents. These openings can pull in generator exhaust.
- Even when you use a generator correctly, CO may leak into the home. ALWAYS use a battery-powered or battery-backup CO alarm in the home.
- If you start to feel sick, dizzy, or weak after the generator has been running, move to fresh air RIGHT AWAY. See a doctor. You could have carbon monoxide poisoning.



WARNING!
THE EXHAUST CONTAINS POISONOUS CARBON MONOXIDE GAS THAT CAN CAUSE LOSS OF CONSCIOUSNESS AND MAY LEAD TO DEATH.

Gasoline and Oil

This product requires oil and fuel. THE ENGINE WILL NOT START WITHOUT OIL. Work in well-ventilated area. Keep cigarettes, flames or sparks away from the work area or where gasoline is stored.



WARNING!

GASOLINE IS EXTREMELY FLAMMABLE AND IS EXPLOSIVE UNDER CERTAIN CONDITIONS. KEEP OUT OF REACH OF CHILDREN.

- Gasoline fuel and fumes are flammable and potentially explosive. Use proper fuel storage and handling procedures. Always have multiple ABC class fire extinguishers nearby.
- Keep the generator and surrounding area clean at all times. Keep the generator at least 5 feet away from buildings and other equipment during operation.
- Fuel or oil spills must be cleaned up immediately. Dispose of fluids and cleaning materials as per any local, state, or federal codes and regulations. Store oily rags in a covered metal container.
- Never store fuel or other flammable materials near the generator.
- Do not smoke, or allow sparks, flames or other sources of ignition around the engine and fuel tank. Fuel vapours are explosive.
- Keep earthed conductive objects, such as tools, away from exposed, live electrical parts and connections to avoid sparking or arcing. These events could ignite fumes or vapours.
- Do not refill the fuel tank while the engine is running or while the engine is still hot. Do not operate the generator with known leaks in the fuel system.
- Excessive build-up of unburned fuel gases in the exhaust system can create a potentially explosive condition. This build-up can occur after repeated failed start attempts, valve testing, or hot engine shutdown.
- Use only engine manufacturer recommended fuel and oil.

Hot Components



WARNING!

HOT EXHAUST CAN BURN YOU. ENGINE AND EXHAUST SYSTEM PARTS BECOME VERY HOT AND REMAIN HOT FOR SOME TIME AFTER THE ENGINE IS RUN. WEAR INSULATED GLOVES OR WAIT UNTIL THE ENGINE AND EXHAUST SYSTEM HAVE COOLED BEFORE HANDLING THESE PARTS.

Work Area

- Keep your work area clean and well lit. Cluttered benches and dark areas invite accidents.
- Do not operate power tools in explosive atmospheres, such as in the presence of flammable liquids, gases, or dust. Generators create sparks which may ignite the dust or fumes.
- Keep bystanders, children, and visitors away while operating a generator. Provide barriers or shields as needed.

Electrical Safety

- Keep all electrical equipment clean and dry. Replace any wiring where the insulation is cracked, cut eroded part or otherwise degraded. Replace terminals that are worn, discoloured, or corroded. Keep terminals clean and tight.
- Insulate all connections and disconnected wires.
- Do not abuse the power cord. Keep power cords away from heat, oil, sharp edges, or moving parts. Replace damaged power cords immediately. Damaged power cords increase the risk of electric shock.
- Do not operate the generator with wet hands. Do not expose generator to rain, snow or wet conditions. Water will increase the risk of electric shock. The generator is a potential source of electrical shock if not kept dry.
- Do not attempt to connect or disconnect load connections while standing in water, or on wet or soggy ground.
- Do not touch electrically energized parts of the generator and interconnecting cables or conductors with any part of the body, or with any non-insulated conductive object.
- Avoid body contact with earthed surfaces such as pipes, radiators, ranges, and refrigerators. There is an increased risk of electric shock if your body is earthed.
- When operating a power tool outside, use a premium quality outdoor extension cord. These extension cords are rated for outdoor use, and reduce the risk of electric shock.

- Earthed tools must be plugged into an outlet properly installed and earthed in accordance with all codes and ordinances. Never remove the earth prong or modify the plug in any way. Do not use any adapter plugs.
- Double insulated tools are equipped with a polarized plug where one blade is wider than the other. This plug fits in a polarized outlet only one way. If the plug does not fit fully in the outlet, reverse the plug. If it still does not fit, contact a qualified electrician to install a polarized outlet. Do not change the plug in any way. Double insulation eliminates the need for the three-wire earthed power cord and earthed power supply system.
- Before servicing equipment powered by the generator, disconnect the equipment from its power input.
- The generator must be earthed for fixed installations in accordance with all relevant electrical codes and standards before operation.
- Earthing provides a low-resistance path to carry electricity away from the user in the event of an electrical malfunction.
- All connections and conduits from the generator to the load must only be installed by trained and licensed electricians and in compliance with all relevant local, state, and federal electrical codes and standards, and other regulations where applicable.
- Connect the generator only to a load or electrical system (240 volt) that is compatible with the electrical characteristics and rated capacities of the generator.
- **NEVER** try to power building or home wiring by plugging the generator into a wall outlet, a practice known as “backfeeding.” This is extremely dangerous and presents an electrocution risk to utility workers and neighbours served by the same utility transformer. It also bypasses some of the built-in household circuit protection devices.

Personal Safety



CAUTION:

DO NOT SIT, STAND, OR PLACE OBJECTS ON TOP OF THE GENERATOR REGARDLESS OF WHETHER IT IS RUNNING OR NOT.

- Stay alert. Watch what you are doing, and use common sense when operating a generator. Do not use generator while tired or under the influence of drugs, alcohol, or medication. A moment of inattention while operating generators may result in serious personal injury.
- Make note of the location of the engine power switch should you need to turn off the generator quickly.

- Dress properly. Contain long hair, clothing, jewellery, and gloves as they can be caught in moving parts.
- Avoid accidental starting. Make sure the power switch is in its “OFF” position, and disconnect the spark plug wire when not in use.
- Remove adjusting keys or wrenches before turning the generator on. A wrench or a key that is left attached to a rotating part of the generator may result in personal injury.
- Do not overreach. Keep proper footing and balance at all times.
- Use safety equipment. Always wear eye protection. Wear AS/NZS approved safety impact eye goggles. Dust mask, non-skid safety shoes, safety gloves, hard hat, or hearing protection must be used for appropriate conditions.
- **Do not use the generator if the power switch does not turn it on or off. Any generator that cannot be controlled with the power switch is dangerous and must be repaired.**
- **Do not force the generator. Use the correct generator for your application. The correct generator will do the job better and safer at the rate for which it is designed.**

Generator Use and Care

- Make sure the power switch is in its “OFF” position and disconnect the spark plug wire before making any adjustment, changing accessories, or storing the generator. Such preventive safety measures reduce the risk of starting the generator accidentally.
- Store idle generators out of reach of children and other untrained persons. Generators are dangerous in the hands of untrained users.
- Maintain generators with care. Do not use a damaged generator. Tag damaged generators “Do not use” until repaired.
- Check for misalignment or binding of moving parts, breakage of parts, and any other condition that may affect the generator’s operation. If damaged, have the generator serviced before using. Many accidents are caused by poorly maintained generators.
- Use only accessories that are recommended by the manufacturer for your model. Accessories that may be suitable for one generator may become hazardous when used on another generator.

Servicing

- Maintain labels and name plates on the generator and engine. These carry important information. If unreadable or missing, contact your Kawashima agent immediately for a replacement.
- Generator service must be performed only by qualified repair personnel. Service or maintenance performed by unqualified personnel could result in a risk of injury.
- When servicing a generator, use only genuine replacement parts. Follow all appropriate instructions in this manual. Use of unauthorized parts or failure to follow maintenance instructions may create a risk of electric shock or injury.



WARNING!

PEOPLE WITH PACEMAKERS SHOULD CONSULT THEIR PHYSICIAN(S) BEFORE USING THIS PRODUCT. ELECTROMAGNETIC FIELDS IN CLOSE PROXIMITY TO A HEART PACEMAKER COULD CAUSE INTERFERENCE TO OR FAILURE OF THE PACEMAKER.

Installation

- Ensure installation meets all applicable safety, and local and national electrical codes. Have installation performed by a qualified, licensed electrician and building contractor.
- All electrical work, including the earth connection, should be completed by a licensed electrician.
- Any separate fuel storage or generator supply facility must be built or installed in full compliance with all relevant local, state, and federal regulations.
- It is recommended to use the generator only in well ventilated outdoor areas. A running gasoline engine will generate carbon monoxide, a colourless, odourless gas that, if inhaled, can cause serious injury or death. If the generator is installed indoors, exhaust fumes must be piped out of the building using leak-free, heat resistant piping. Pipes and silencer should not use any flammable materials, nor should they be installed near the same. Generator exhaust fumes must be within legal limits and installation must always meet local building codes.
- If the generator is installed outdoors, it must be weatherproofed and should be soundproofed. It should not be run outdoors without protection of the generator and wiring conduit.
- The supporting floor/ground surface should be level, and strong enough to safely hold the weight of the generator.

Mechanical

- Always make sure the power switch is in its “OFF” position. Disconnect the spark plug wire, and allow the engine to completely cool before carrying out maintenance.
- Check for damaged parts. Before using the generator, any part that appears damaged should be carefully checked to determine that it will operate properly and perform its intended function. Check for alignment and binding of moving parts, any broken parts or mounting fixtures, and any other condition that may affect proper operation technician.
- The generator is designed with guards for protection from moving parts. In any case, care must still be taken to protect personnel and equipment from other mechanical hazards when working around the generator.
- Do not operate the generator with safety guards removed. While the generator is running, do not attempt to reach around the safety guard for maintenance or any other reason.
- Keep hands, arms, long hair, loose clothing, and jewellery away from moving parts. Be aware that when engine parts are moving fast they cannot be seen clearly.
- Keep access doors on enclosures closed and locked when access is not required.
- When working on or around the generator always wear protective clothing including AS/NZS approved safety gloves, safety eye goggles, and safety hat.
- Do not alter or adjust any part of the generator that is assembled and supplied by the manufacturer.
- Always follow and complete scheduled engine and generator maintenance.

Chemicals

- Avoid contact with hot fuel, oil, exhaust fumes, and hot solid surfaces.
- Avoid body contact with fuels, oils, and lubricants used in the generator. If swallowed, seek medical treatment immediately. Do not induce vomiting if fuel is swallowed. For skin contact, immediately wash with soap and water. For eye contact, immediately flush eyes with clean water and seek medical attention.

Noise

Prolonged exposure to noise levels above 85dBA is hazardous to hearing. Always wear AS/NZS approved ear protection when operating or working around the Generator when it is running.

Extension Cords

If an extension cord (not included) is used, make sure to use only AS/NZS approved cords having the correct gauge and length according to the following table:

Output Load (W)	Cord Lengths	
	15m	15-30m
0-700	1.5mm ²	2.5mm ²
700-1000	1.5mm ²	2.5mm ²
1000-1300	2.5mm ²	2.5mm ²
1300-1600	2.5mm ²	2.5mm ²
1600-1800	2.5mm ²	2.5mm ²

SECTION 2:

Controls and Features

2.1 Generator

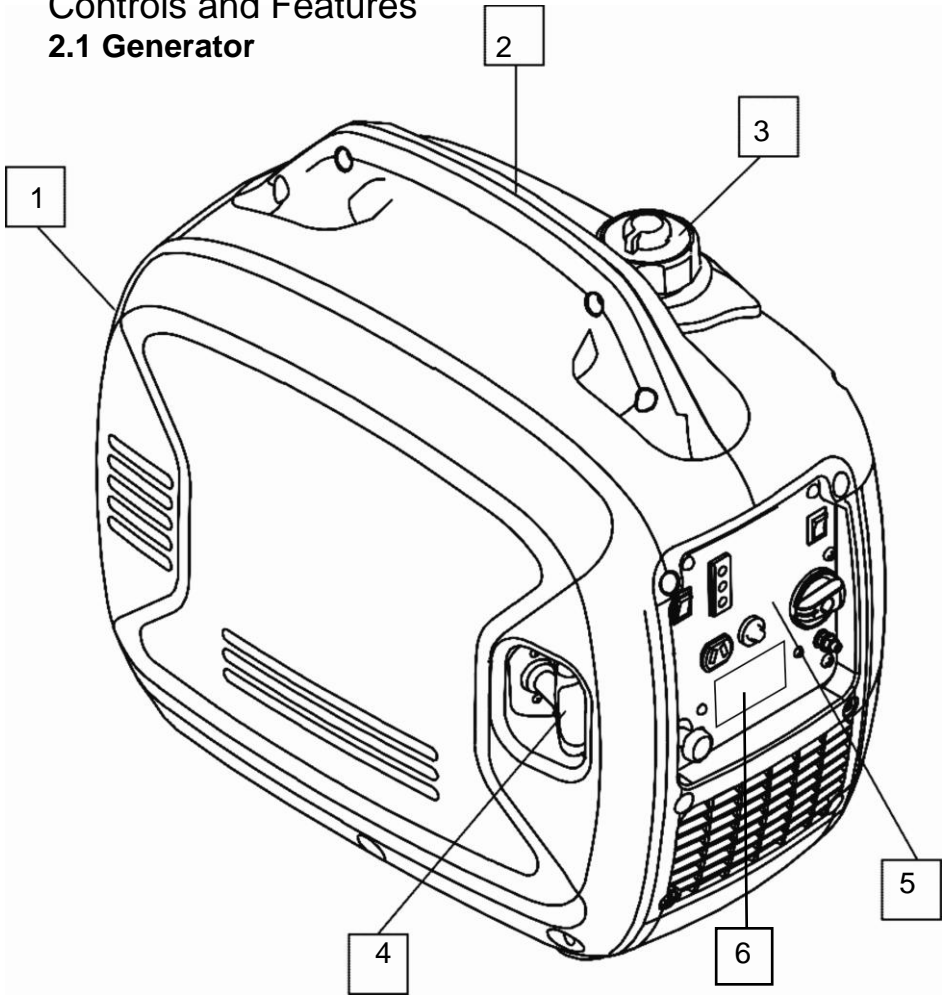

- 1. Exhaust and Spark Arrestor
- 2. Carrying handle
- 3. Vented Gas Cap
- 4. Recoil Starter Rope
- 5. Control Panel
- 6. 240V Power Outlet

2.2 Control Panel

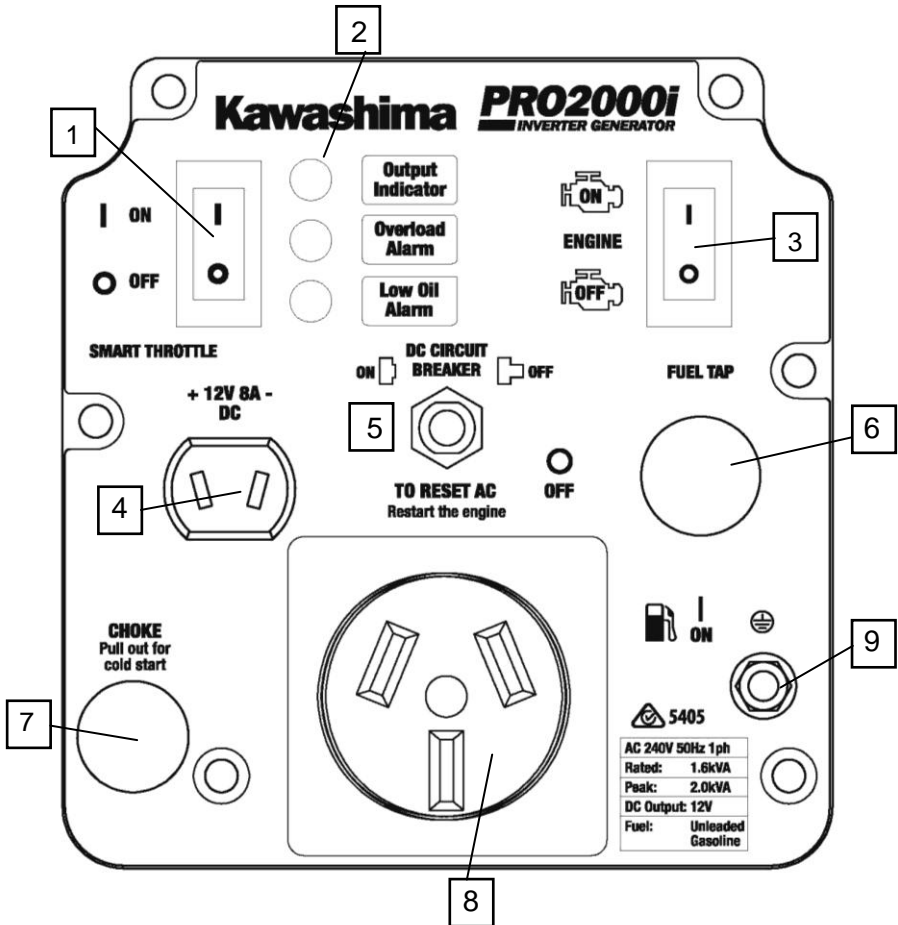

1. Smart Throttle Switch
2. LED Indicators
3. Engine Switch
4. 12V DC Output
5. 8A DC Circuit Breaker
6. Fuel Tap
7. Choke
8. 240V AC Outlet
9. Earth Connector

2.3 Control Functions

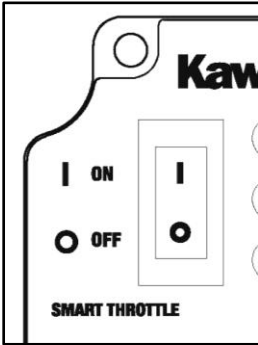

Smart Throttle

When the Smart Throttle switch is in the “ON” position the smart throttle controls the engine speed according to the connected electrical load. The results are better fuel consumption and less noise. When the switch is in the “OFF” position the engine runs at 4,500 rpm regardless of the electrical load.



Note:

The Smart Throttle must be “OFF” when using electrical devices that require a large starting current, such as a compressor, pump, or refrigerator.

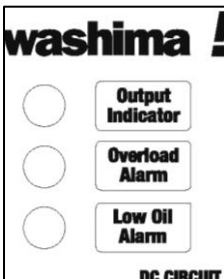

LED Indicators

The LED Indicators assist in communicating proper and improper functions of the unit.

Output Indicator (Green)

The Output Indicator comes on when the engine starts and produces power.

Overload Alarm (Red)

The Overload Alarm comes on when a connected device requires more power than the generator is able to produce, the inverter control unit overheats, or the AC output voltage rises above rated values. The Output Indicator (Green) will go off and the Overload Alarm (Red) will stay on, but the engine will continue to run.

When the Overload Alarm light comes on and power generation stops, proceed as follows:

1. Turn off any connected electric devices and stop the engine.
2. Reduce the total wattage of connected electric devices within the rated output.
3. Check for blockages in the cooling air inlet and around the control unit. If any blockages are found remove them.
4. After checking, restart the engine.



Note:

The Overload Alarm may come on for a few seconds when first using electrical devices that require a large starting current, such as a compressor, pump, or refrigerator. This is normal behaviour it is not a malfunction.

Low Oil Alarm (Red)

When the engine oil falls below the required level the Low Oil Alarm will come on and the engine will stop automatically. The engine will not restart until oil is added to the unit to bring it up to the appropriate level.



Note:

When starting the unit, if the Low Oil Alarm light flickers and the engine will not start, you will need to add engine oil before attempting to restart the engine.



Note:

Generator should only be operated on a level surface. DO NOT operate the generator on loose ground or obvious inclines. The low oil shutdown feature may be prematurely activated in these cases causing the engine to not start.

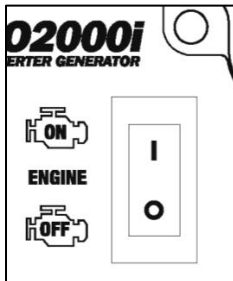

Engine Switch

The Engine Switch controls the ignition switch. The switch must be in the "ON" position to start the generator. Switching to the "OFF" position stops the engine and will not allow the engine to be restarted.

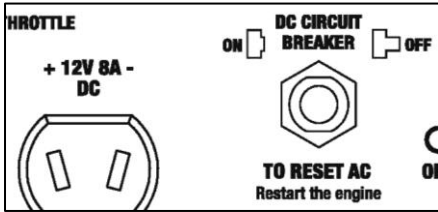

12V 8A DC Outlet

The 12V 8A DC Outlet is provided for battery charging. Follow instructions in the owner's manual for the battery for charging procedures.

8A DC Circuit Breaker

The 8A DC Circuit Breaker turns off automatically if the current exceeds 8A. If the circuit breaker turns "OFF" you will need to push it "in" to turn it "ON" again.

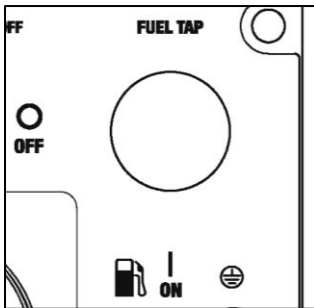

Fuel Tap

The Fuel Tap controls the flow of gasoline from the fuel tank to the carburettor. The Tap knob should be in the "ON" position when starting and operating the generator. The Tap knob should be in the "OFF" position when the engine is not running and when storing or transporting the unit.



Note:

The Fuel Tap knob helps to prevent stale fuel from remaining in the carburettor while storing or transporting the unit. Run the fuel out by turning the knob to the "OFF" position and letting the engine run until it stops.

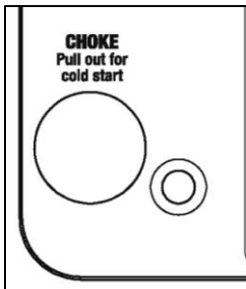

Choke

The Choke is used when starting the engine "cold" (the engine is not hot). Pull out fully on the choke when starting the engine. Once the engine has warmed and a steady idle is achieved, push in on the choke. NOTE: When restarting a warm engine the choke is not necessary.

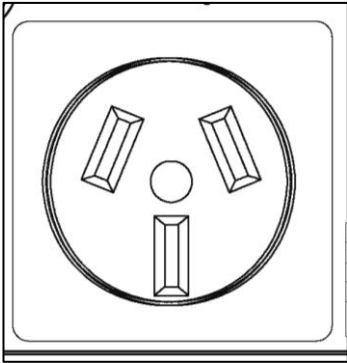

240V AC Outlet

The Outlet is used to power 240V Single Phase 50Hz loads requiring up to 1600W continuous power.

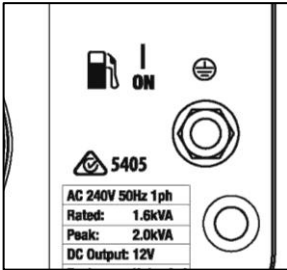

Earth

The Earth terminal is used to earth the generator when earthed electrical devices are being used. Consult an electrician for local earthing regulations.

SECTION 3:

Getting Started

3.1 Unpack the Generator

Remove the generator from its packaging.



WARNING!
PACKAGING IS FLAMMABLE!
DO NOT ATTEMPT TO ADD FUEL TO THIS UNIT
BEFORE REMOVING IT FROM PACKAGING.

Inspect the generator to ensure that no damage has occurred in shipping or handling. If the unit appears to be damaged, DO NOT add fuel or attempt to start the generator. Please call Kawashima customer service at 0800 387 678 (NZ) or 1800 040 947 (AUS).

Check to ensure that you received the following items:

- PRO2000i 2000W Generator
- 12V Charging Cables
- 400ml Oil
- Oil Funnel

If you did not receive any of the above items, please contact Kawashima customer service at 0800 387 678 (NZ) or 1800 040 947 (AUS).

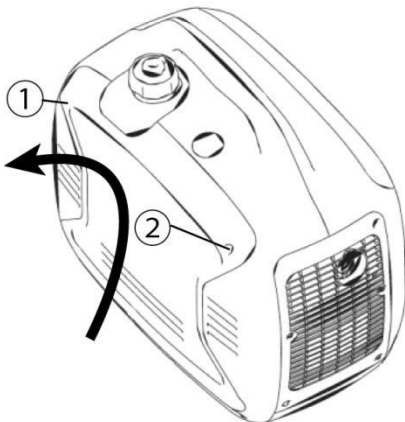

Figure 1

3.2 Adding Engine Oil The generator has been shipped without engine oil. DO NOT add fuel or start the engine before adding engine oil.

IN ORDER TO ADD MOTOR OIL YOU WILL NEED TO REMOVE THE SIDE PANEL FROM THE UNIT.

Using a #2 Phillips-head screwdriver remove screws ① and ② (seen in figure 1) and lift up and away to remove the side panel.

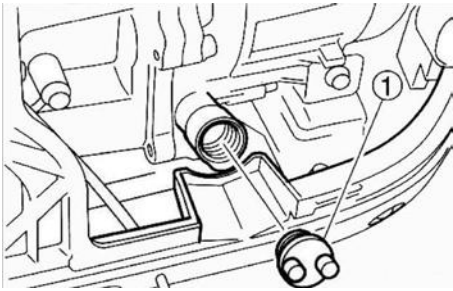

Figure 2

Place the generator on a level surface. DO NOT tilt the generator while adding oil. It can cause you to overfill the oil and/or cause the oil to leak into areas in which it is not intended.

Remove the oil filler cap ① (seen in figure 2)

Using the funnel (provided) fill with 0.4L of SAE 10W-30 or 10W-40 (provided) (see figure 3). See figure 4 for proper oil level ①.

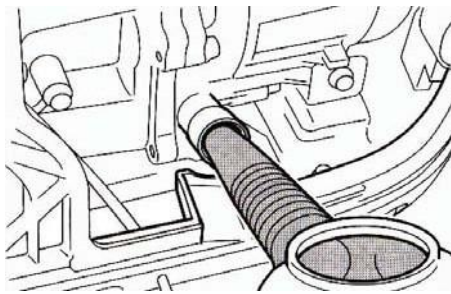

Figure 3

Replace oil filler cap and secure side panel with screws.

Recommended engine oil:

- A. YAMALUBE 4 (10W-40)
SAE10W-30 or 10W-40
- B. SAE #30
- C. SAE#20
- D. SAE#10W

Recommended engine oil grade: API Service SE type or higher Engine oil quantity:

0.4L

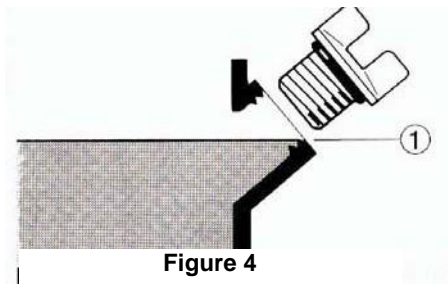

Figure 4

3.3 Adding Fuel

The fuel tank holds 4 litres.

DO NOT overfill the tank, otherwise it may overflow when the fuel warms up and expands.



Note:

For safety reasons, once fuel has been added to this unit it cannot be returned to the place of purchase.

1. Use clean, fresh, regular unleaded fuel with a minimum octane rating of 91.
2. DO NOT mix oil with fuel.
3. Clean area around the fuel cap.
4. Remove the fuel cap.
5. Be sure that the fuel strainer is in place.
6. Slowly add fuel to the tank. DO NOT overfill. Allow approximately $\frac{1}{4}$ inch of space for fuel expansion.
7. DO NOT fill above fuel strainer.
8. Screw on the fuel cap and wipe away and spilled fuel.

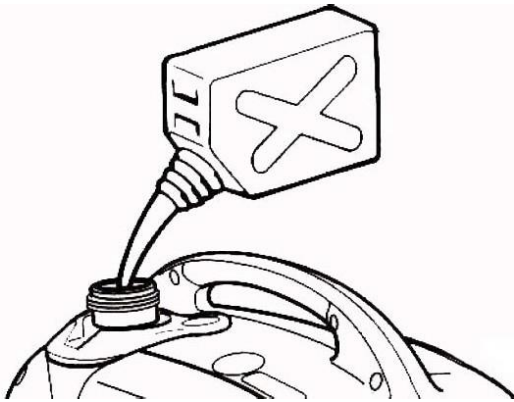

Note:

*Use only unleaded gasoline.
The use of leaded gasoline will cause severe damage to internal engine parts.*

After filling with fuel, make sure the fuel tank cap is tightened securely.

3.4 Starting the Engine

OPERATE THE ENGINE IN A WELL VENTILATED AREA.

DO NOT connect any electrical devices to the outlets on the generator before starting the engine.

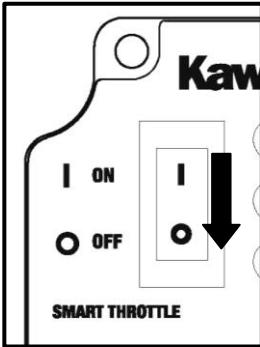

1. Turn the Smart Throttle switch "OFF"

You may turn the Smart Throttle switch to "ON" once the engine is started and a steady idle is achieved. (below 0°C 5mins, below 5°C 3mins.)

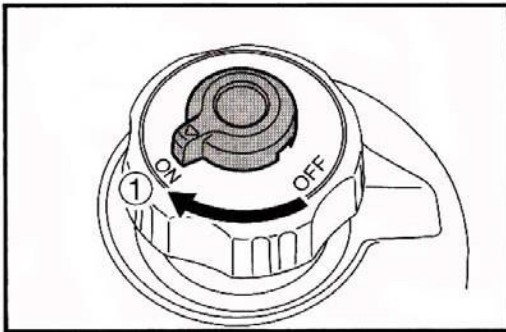

2. While holding the fuel tank cap so that it will not move, turn the air vent knob to "ON".

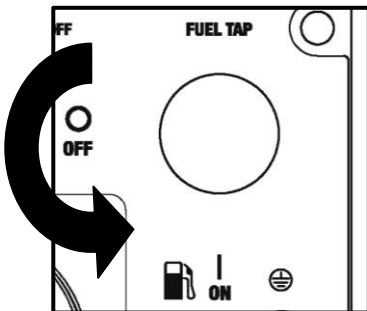

3. Turn the Fuel Tap knob to the "ON" position.

4. Turn the Engine Switch (Red) "ON"

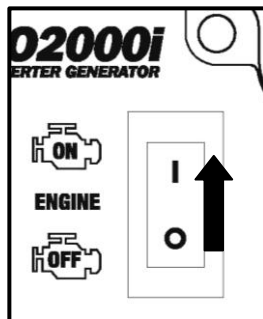
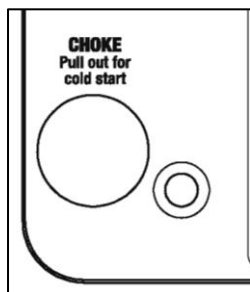

5. Pull the Choke Knob fully out.



Note:

The Choke is not needed to start a warm engine. Push the knob in to the original position when starting the engine warm.



6. Grasp the carrying handle firmly to prevent the generator from falling over when pulling the recoil starter.

7. Pull slowly on the recoil starter until it is engaged and then pull it briskly.

8. After the engine starts, warm up

the engine until the engine does not stop when the choke knob is returned the original position.

3.5 Stopping the Engine

Before stopping the engine turn off and disconnect any electronic devices attached to the generator.

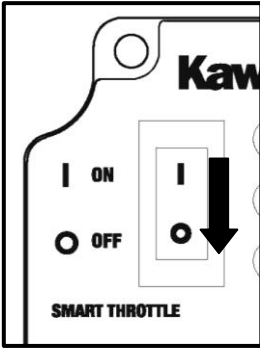

Turn the Smart Throttle switch “OFF”

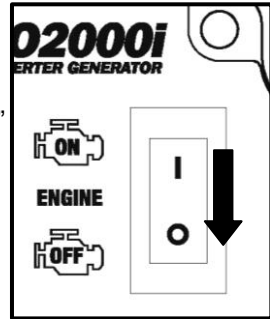

Turn the Engine Switch to “OFF”

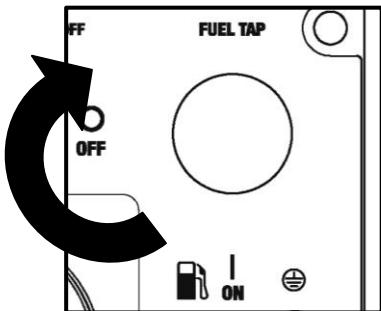

Turn the Fuel Tap to “OFF”

SECTION 4:

Electrical Connection

4.1 Capacity

Follow these simple steps to calculate the running and starting watts necessary for your purposes.

See Section 4.5 for Wattage Reference Guide.

1. Select the electrical devices you plan on running at the same time.
2. Total the running watts of these items. This is the amount of power you need to keep your items running.
3. Identify the highest starting wattage of all devices identified in step
 - a. Add this number to the number calculated in step
 - b. Surge wattage is the extra burst of power needed to start some electric driven equipment. Following the steps listed under "Power Management" will guarantee that only one device will be starting at a time.

4.2 Power Management

Use the following formula to convert voltage and amperage to watts:

Volts x Amps = Watts

To prolong the life of your generator and attached devices, follow these steps to add electrical load:

1. Start the generator with no electrical load attached.
2. Allow the engine to run for several minutes to stabilize.
3. Plug in and turn on the first item. It is best to attach the item with the largest load first.
4. Allow the engine to stabilize.
5. Plug in and turn on the next item.
6. Allow the engine to stabilize.
7. Repeat steps 5-6 for each additional

4.3 Connecting Electrical Loads

1. Let the engine stabilize and warm up a few minutes after starting.

2. Prior to powering tools and equipment, make sure the generator's rated voltage, and amperage capacity (240V AC 1600 watts continuous, 2000 watts peak) is adequate to supply all electrical loads that the unit will power. If powering exceeds the generator's capacity, it may be necessary to group one or more of the tools and/or equipment for connection to a separate generator.
3. Once the generator is running, simply connect the power cords of the 240 volt AC powered tools and equipment into the 240 volt AC outlet and/or the power cord of a 12V DC item to the DC terminals..
4. DO NOT connect 3-phase loads to the generator.
5. DO NOT overload the generator.



Note: *The DC terminals may be used for charging 12 volt automotive type batteries only.*

4.4 Battery Charging

Start the engine first and allow it to reach idle before connecting the generator to the battery. Battery Charging is performed using the 12V DC outlet only.

1. Be sure the Smart Throttle switch is turned “**OFF**” while charging batteries.
2. Be sure to connect the red battery charger lead to the positive (+) battery terminal, and connect the black lead to the negative (-) battery terminal. DO NOT reverse these positions.
3. Connect the battery charger leads to the battery terminals securely so that they are not disconnected due do engine vibration or other disturbances.
4. Charge the battery by following the instructions in the owner's manual for the battery.
5. The DC Circuit Breaker will turn “**OFF**” automatically if the current exceeds rated output.
6. To restart charging the battery, turn the DC protector on by pressing its button to “**ON**”
7. Refer to the owner's manual for the battery to determine charging times.



Note: *Never start or stop the generator with electrical devices plugged in or turned on.*

4.5 Wattage Reference Guide

Item	Running Watts	Starting Watts
Essentials		
Light Bulb	100	100
Refrigerator/Freezer	1200	2400
Sump Pump	600	1800
Well Pump 1HP	2000	4000
Water Heater	4000	
Security System	180	
AM/FM Radio	300	
Garage Door Opener ½ HP	500	600
Battery Charger 12V	110	
Heating and Cooling		
Air Conditioner 12000 BTU	1700	2500
Fan	300	600
Furnace Fan 1/3 HP	1200	2000
Home Appliances		
Microwave	1000	
Electric Range – One Element	1500	
Electric Skillet	1250	
Coffee Maker	1500	
Clothes Washer	1200	
Entertainment		
CD/DVD Player	100	
Stereo Receiver	450	
Television 27"	500	
PC with 15" Monitor	800	
Job Site		
Belt Sander 3"	1000	1500
Bench Grinder 6"	700	1500
Circular Saw	1500	1500
Compressor 1 ½ HP	1000	1000
Edge Trimmer	500	500
Hand Drill ½"	1000	1000
Paint Sprayer	600	1200
Table Saw	2000	2000

These are estimates only. Check your tool or appliance for exact wattage requirements. The wattages listed are based on estimated wattage requirements.

For exact wattages, check the data plate or owner's manual on the item you wish to power using the generator.

Operating voltage and frequency requirement of all electronic equipment should be checked prior to plugging to plugging them into this generator. Damage may result if the equipment is not designed to operate within a +/- 10% voltage variation, and +/- 3 Hz frequency variation from the generator specification ratings.

Your Power Needs

Tool or Appliance	Running Watts	Starting Watts
1.		
2.		
3.		
4.		
5.		
Total Running Watts		
	Highest Starting Watts	

**Total Running Watts
+ Highest Starting Watts**

SECTION 5:

Maintenance

5.1 Periodic Maintenance

Periodic inspection, adjustment and lubrication will keep your generator in the safest and most efficient condition possible.

Item	Routine	Prior to use	Every	
			6 months or 100hrs.	12 months or 300hrs.
Spark Plug	<ul style="list-style-type: none"> • Check condition • Clean and replace if necessary 		•	
Fuel	<ul style="list-style-type: none"> • Check fuel level and leakage. 	•		
Fuel hose	<ul style="list-style-type: none"> • Check fuel hose for cracks or damage • Replace if necessary. 	•		
Engine oil	<ul style="list-style-type: none"> • Check oil level in engine. 	•		
	<ul style="list-style-type: none"> • Replace* 		•*	
Air Filter Element	<ul style="list-style-type: none"> • Check condition • Clean 		•	
Muffler Screen	<ul style="list-style-type: none"> • Check Condition • Clean or replace if necessary 		•	
Spark Arrestor	<ul style="list-style-type: none"> • Check Condition • Clean or replace if necessary 		•	
Fuel Filter	<ul style="list-style-type: none"> • Check Condition • Clean or replace if necessary 			•

* Initial replacement of the engine oil is after one month or 20 hours of operation.

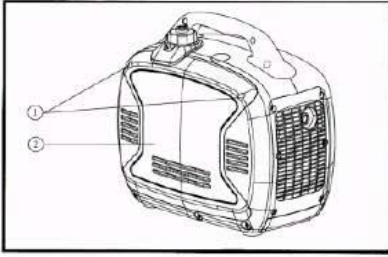

5.2 Spark Plug Maintenance

Spark plug inspection

The spark plug is an important engine component and should be checked periodically.

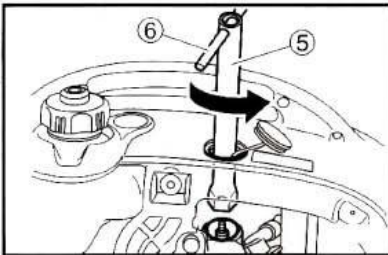
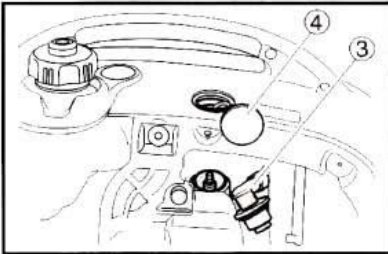

1. Remove the screws ① and then remove the cover ②.
2. Remove the spark plug cap ③ and access cap ④
3. Insert the tool ⑤ through the hole in the outside of the cover.
4. Insert the handlebar ⑥ into the tool ⑤ and turn it counter clockwise to remove the spark plug.
5. Check for discoloration. The carbon porcelain insulator around the centre electrode of spark plug should be a Medium-to-light tan colour.
6. Check the spark plug type and gap. The spark plug gap should be measured with a wire thickness gauge and, if necessary, adjusted to specification.

Spark Plug Type:

BPR6HS (NGK)

Spark Plug Gap:

0.6-0.7 mm (0.024-0.028 in)

Spark Plug Torque:

20.0 N·m (2.0kgf·m, 14.8 lbf·ft)

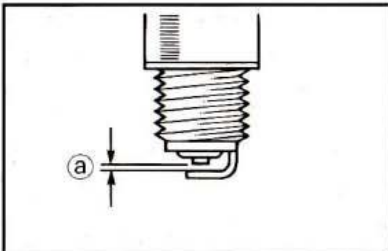

7. Install spark plug, spark plug cap, cover and screws.

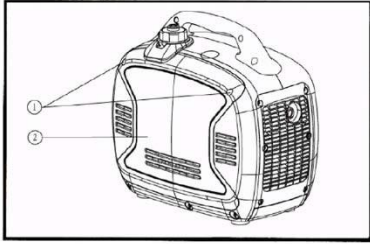

5.3 Engine Oil Replacement

Initial replacement of the engine oil is after one month or 20 hours of operation.

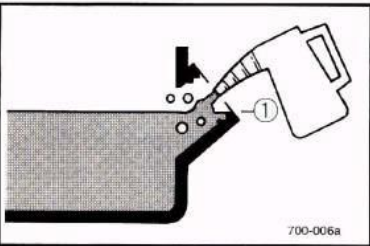
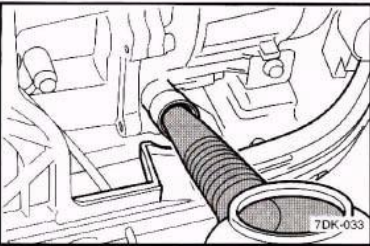
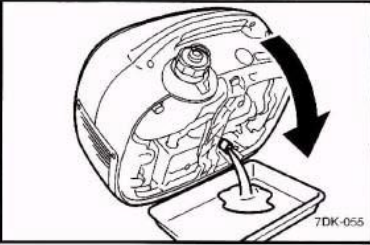
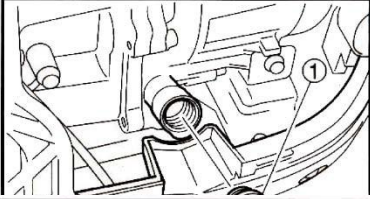

1. Place the generator on a level surface and warm up the engine for several minutes. Then stop the engine and turn the Fuel Tap knob to “**OFF**” and the Fuel Tank Cap Air Vent knob to “**OFF**”.
2. Remove the screws (1) and then remove the cover (2).
3. Remove the oil filler cap.
4. Place an oil pan under the engine. Tilt the generator to drain the oil completely.
5. Return the generator to a level surface.

Note: *DO NOT tilt the generator when adding engine oil. This could result in overfilling and damage to the engine.*

6. Add engine oil to the upper level as seen in the diagram (1).

Recommended engine oil:

• YAMALUBE 4 (10W-40), SAE 10W-30 or 10W-40

- SAE#30
- SAE#20
- SAE10W

Recommended engine oil grade:

API Service SE type or higher

Engine oil quantity:

0.4 Litre

7. Install oil filler cap, cover, and screws.

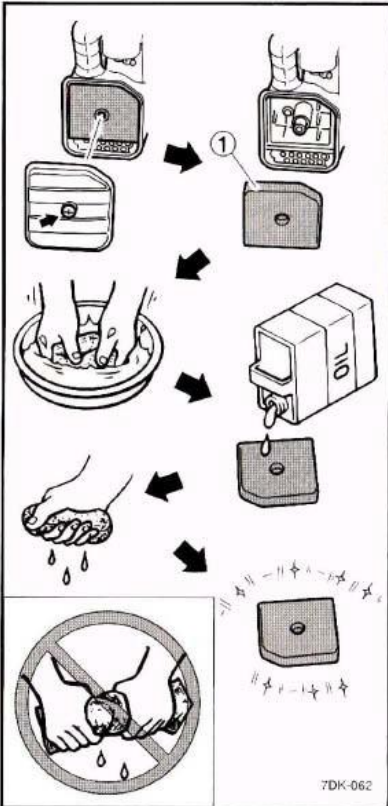
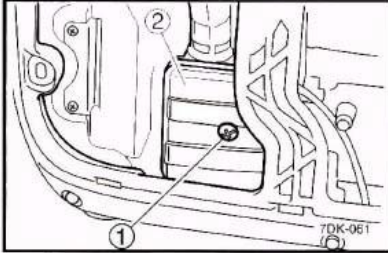
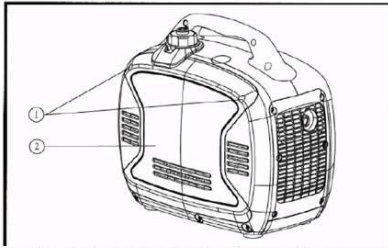

5.4 Air Filter Maintenance Should be performed every 6 months or 100 hours. The air filter may need to be cleaned more frequently when using in unusually wet or dusty areas.

1. Remove the screws ① and then remove the cover ②.
2. Remove the screws ① and then remove the air filter case cover ②.
3. Remove the foam element ①.
4. Wash the foam element in solvent and dry it.
5. Oil the foam element and squeeze out excess oil. The foam element should be wet but not dripping.

NOTE: Do not wring out the foam element when squeezing it. This could cause it to tear.

6. Insert the foam element into the air filter case. Be sure the foam element sealing surface matches the air filter so there is no air leak.

NOTE: The engine should never run without the foam element.

7. Install air filter case cover, cover, and screws.

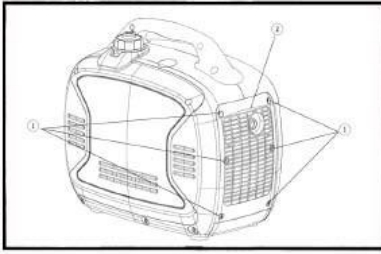

5.5 Muffler Screen and Spark Arrester Maintenance

Should be performed every 6 months or 100 hours. The air filter may need to be cleaned more frequently when using in unusually wet or dusty areas.

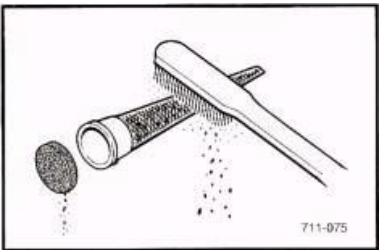
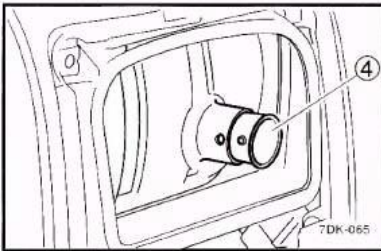
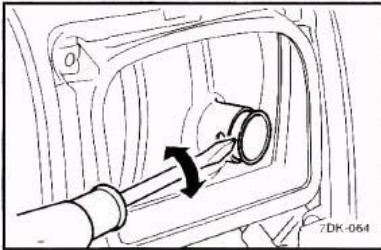
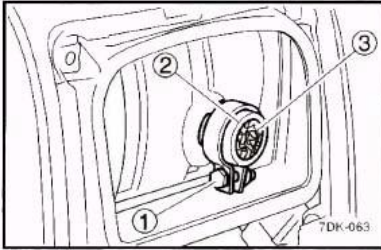

1. Remove the screws ① and then remove the cover ②.
2. Loosen the bolt ① and the remove the muffler cap ②, the muffler screen ③ and spark arrester ④
3. Remove the carbon deposits on the muffler screen and spark arrester using a wire brush. Use wire brush lightly to avoid damaging the muffler screen or spark arrester.
4. Check the muffler screen and spark arrester replace them if damaged.
5. Install the spark arrester.
6. Install the muffler cap.
7. Install the cover and tighten the screws.

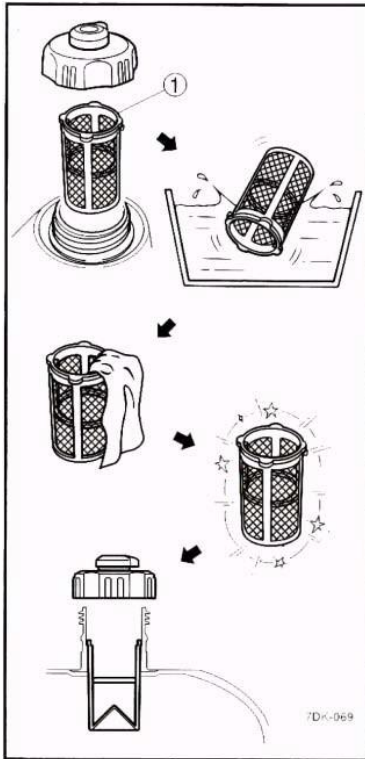

5.6 Fuel Filter Maintenance

Should be performed every 12 months or 300 hours.

1. Remove the fuel tank cap and filter ①.
2. Clean the filter with gasoline.
3. If damaged, replace it.
4. Wipe the filter and install it.
5. Install the fuel tank cap.

WARNING!

GASOLINE IS FLAMMABLE. DO NOT perform this maintenance while smoking or near an open flame.

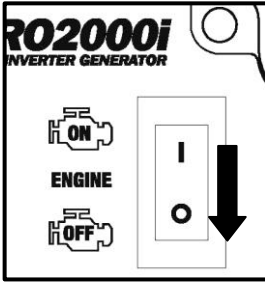

SECTION 6:

Storage

6.1 Long Term Storage

Long term storage of your machine will require some preventive procedures to guard against deterioration.

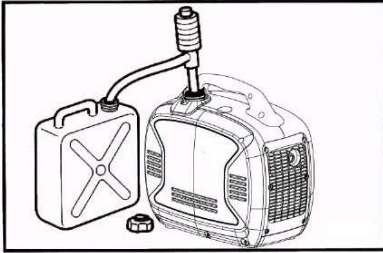

Drain the fuel

1. Turn the Engine switch to "OFF" ①.
2. Remove the fuel tank cap. Extract the fuel tank into an approved gasoline container using a commercially available hand siphon. Then, install the fuel tank cap.

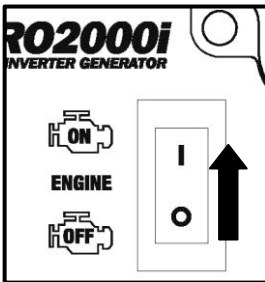

WARNING!

GASOLINE IS FLAMMABLE. DO NOT perform this maintenance while smoking or near an open flame.

Immediately wipe off spilled fuel with a clean, dry, soft cloth, since fuel may deteriorate painted surfaces or plastic parts.

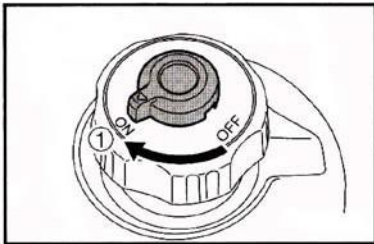

3. Turn the Engine switch to "ON".
4. Turn the fuel tank cap air vent knob and Fuel Tap knob to "ON" ①.
5. Start the engine and let it run until it stops. Duration of the running engine depends on the amount of the fuel left in the tank.

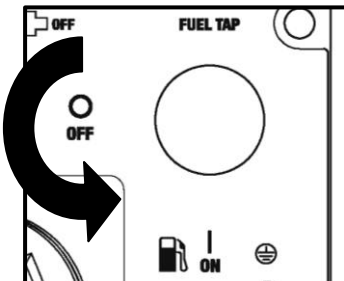

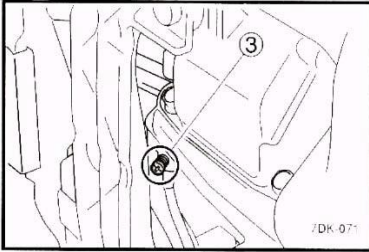
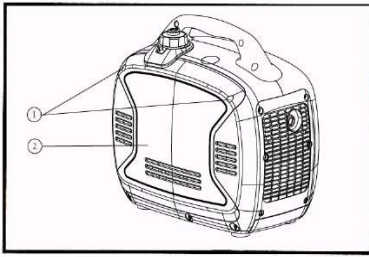

6. Remove the screws ①, and then remove the cover ②.
7. Drain the fuel from the carburettor by loosening the drain screw ③ on the carburettor float chamber.
8. Turn the Engine switch to **“OFF”**
9. Turn the fuel cock knob to **“OFF”**
10. Tighten the drain screw
11. Install the cover and tighten the screws.
12. Turn the fuel tank cap air vent knob to **“OFF”**
13. Store the generator in a dry, well-ventilated place, with the cover placed over it.

Engine

Perform the following steps to protect the cylinder, piston ring, etc. from corrosion.

1. Remove the spark plug, pour about one table-spoon of SAE 10W-30 or 20W-40 motor oil into the spark plug hole and reinstall the spark plug. Recoil start the engine by turning over several times (with ignition off) to coat the cylinder walls with oil.
2. Pull the recoil starter until you feel compression. Then stop pulling (this prevents the cylinder and valves from rusting).
3. Clean exterior of the generator and apply a rust inhibitor.
4. Store the generator in a dry, well-ventilated place, with the cover placed over it.
5. The generator must remain in a vertical position when stored, carried, or operated

SECTION 7:

Troubleshooting and Specifications

7.1 Troubleshooting Diagram

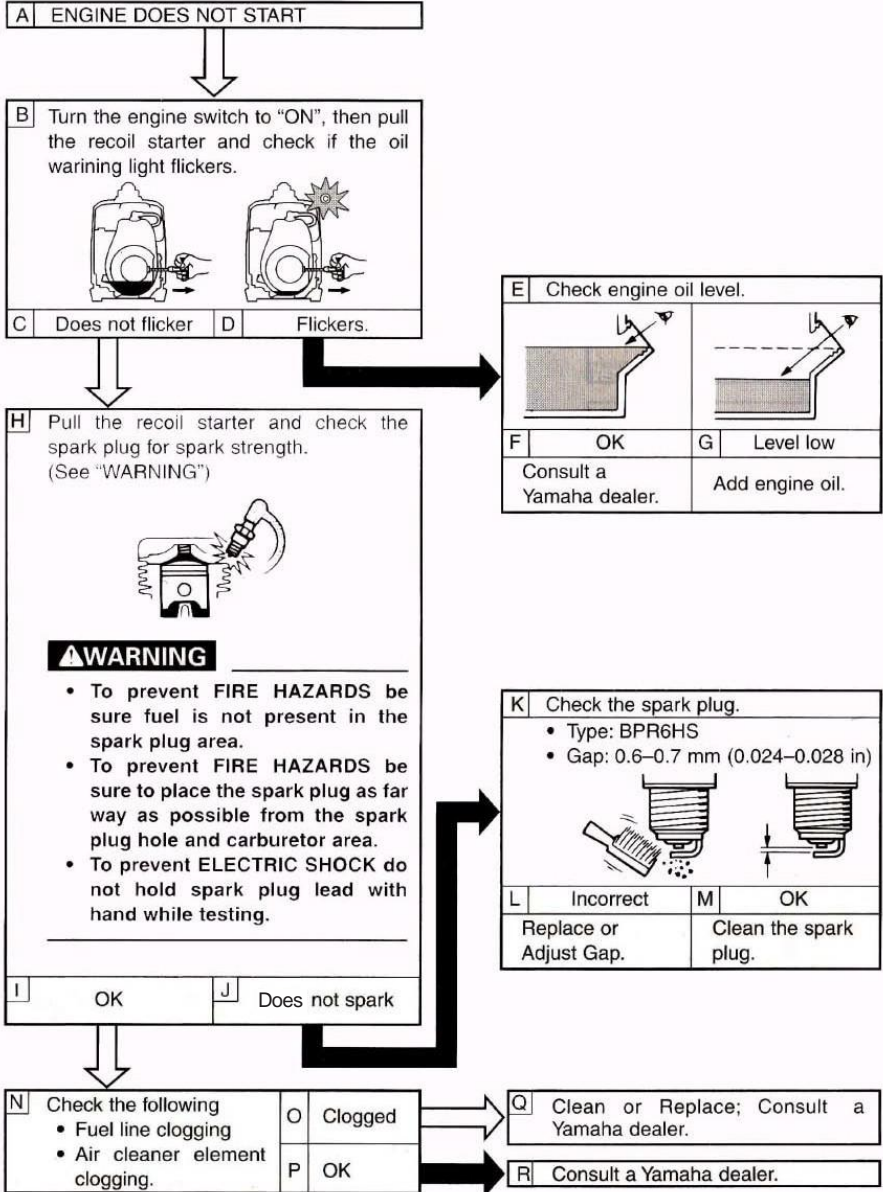

7.2 Fuel Filter Maintenance

Use this section to troubleshoot common errors.

Engine won't start

Fuel systems: No fuel supplied to combustion chamber

- No fuel in tank.....supply fuel.
- Fuel in tank.....Fuel tank cap air vent knob and fuel cock knob to “ON”.
- Clogged fuel line.....clean fuel line.
- Clogged carburettor....clean carburettor.

Engine oil system insufficient

- Oil level is low....add engine oil.

Electrical systems

- Engine switch to “ON” and pull the recoil starter. Poor spark
- Spark plug dirty with carbon or wet...Remove carbon or wipe spark plug dry.
- Faulty ignition system....Consult a service centre.

Generator won't produce power

- Safety device (DC protector) to ”OFF”press the DC protector to “ON”
- Safety device (AC) to “OFF”stop the engine, then restart.

7.3 Specifications

Engine Type	4-Stroke OHV Yamaha MZ80 Air Cooled Single Cylinder
Engine Displacement (cc)	79cc
Running Watts	1600w
Starting Watts	2000w
Rated Frequency	50HZ
Rated Voltage	240V
Rated Current	6.7A
Run Time	10.5hrs at 1/4 load
Receptacles (qty.)	(2) 240V AC; (1) 12V 8A DC
Net Weight	20kg
Noise Level (dB)	51dB @ 1/4 Load
Fuel Type	Unleaded gasoline
Fuel Capacity (litres)	4.2
Oil Type	SAE 10W-30
Start Type	Recoil
Dimensions L x W x H	50cmx28cmx45cm approx.

Warranty

Whilst every effort is made to ensure your complete satisfaction with this tool, occasionally, due to the mass manufacturing techniques, a tool may not live up to our required level of performance and you may need the assistance of our service department.

This product is warranted for a 12 month period for domestic use and a 3 month period for commercial use from the date of the original purchase. If found to be defective in materials or workmanship, the tool or the offending faulty component will be replaced free of charge with another of the same item. A small freight charge may apply. Proof of purchase is essential.

We reserve the right to reject any claim where the purchase cannot be verified. This warranty does not include damage or defects to the tool caused by or resulting from abuse, accidents, alterations or commercial or business use. It also does not cover any bonus items or included accessories. Only the generator is covered under this warranty.

Please ensure that you store your receipt in a safe place. Conditions apply to the above warranty.

1. DURATION: The manufacturer warrants that it will repair or replace, at no charge for parts or labour, the KAWASHIMA Generator, if proven defective in material or workmanship, during the following time period(s) after date of original retail purchase:

For 1 Year:

The KAWASHIMA PRO2000i Generator (excluding accessories)

2. WHO GIVES THIS WARRANTY (Warrantor):

EUROQUIP NZ EUROQUIP AUSTRALIA

Service Line: Service Line:
+ 64 3 547 8409 1 - 800 040 947

3. WHO RECEIVES THIS WARRANTY (Purchaser):

The original purchaser of this KAWASHIMA Generator

4. WHAT IS COVERED UNDER THIS WARRANTY:

Defects in material and workmanship which occur within the duration of the warranty period.

5. WHAT IS NOT COVERED UNDER THIS WARRANTY:

A. Implied warranties, including those of merchantability and FITNESS for a particular purpose are limited in duration to this express warranty. After this period, all risks of loss, from whatever reason, shall be on the purchaser.

B. ANY INCIDENTAL, INDIRECT, OR CONSEQUENTIAL LOSS, DAMAGE, OR EXPENSE THAT MAY RESULT FROM ANY DEFECT, FAILURE OR MALFUNCTION OF THIS PRODUCT.

C. This warranty does not apply to any accessory or consumable items included with the product which are subject to wear from usage; the repair or replacement of these items shall be at the expense of the owner. These items include, but are not limited to: sparkplugs, seals, O-rings, recoil starter parts, etc. In addition, this warranty does not extend to any damage caused by the untimely replacement or maintenance of any of the previously listed CONSUMABLE parts.

D. Any failure that results from accident, purchaser's abuse, neglect or failure to operate products in accordance with instructions provided in the owner's manual(s) supplied with the product.

E. Pre-delivery service, i.e. assembly and adjustment.

6. RESPONSIBILITIES OF WARRANTOR UNDER THIS WARRANTY:

Repair or replace, at Warrantor's option, products or components which have failed within duration of the warranty period.

7. RESPONSIBILITIES OF PURCHASER UNDER THIS WARRANTY:

A. Please call your re-seller or the number listed above for warranty assistance.

B. Provide dated proof of purchase and maintenance records.

C. All generators must be delivered or shipped to the nearest Service Agent or re-seller. Freight costs, if any, must be borne by the purchaser.

D. Use reasonable care in the operation and maintenance of the products as described in the owner's manual(s).

E. No warranty costs incurred will be considered for, or covered if Euroquip has not been contacted and prior permission for repair / replacement has been granted.

8. WHEN WARRANTOR WILL PERFORM REPAIR OR REPLACEMENT UNDER THIS WARRANTY:

Repair or replacement will be scheduled and serviced according to the normal work flow at the servicing location and depending on the availability of replacement parts.